



This manual is for reference and historical purposes, all rights reserved.

This page is copyright© by M. Butkus, NJ.

This page may not be sold or distributed without the expressed permission of the producer

I have no connection with any camera company

On-line camera manual library

This is the full text and images from the manual. This may take 3 full minutes for the PDF file to download.

If you find this manual useful, how about a donation of \$3 to: M. Butkus, 29 Lake Ave., High Bridge, NJ 08829-1701 and send your e-mail address so I can thank you. Most other places would charge you \$7.50 for a electronic copy or \$18.00 for a hard to read Xerox copy.

This will allow me to continue to buy new manuals and pay their shipping costs.

It'll make you feel better, won't it?

**If you use Pay Pal or wish to use your credit card,
click on the secure site on my main page.**

Canon

EOS-1 N

EOS-1 N RS



English Edition **E**
INSTRUCTIONS

Thank you for selecting a Canon EOS camera.

Thousands of professional photographers throughout the world are devoted users of the EOS-1 — a flexible, high-precision tool responsible for recording on film countless decisive moments and masterpieces of photographic art. The EOS-1 N continues the EOS-1 tradition and extends the state of the art even further by combining all of the superb features of the EOS-1 with several new functions and mechanisms requested by EOS-1 users to create the ultimate professional photographic tool.

New Features include:

1. Advanced Multi-BASIS AF (autofocus) sensor with five selectable focusing points for wide-area coverage.
2. Improved focus prediction and object tracking performance.
3. Improved shooting speed (up to 6 frames/sec. with Power Drive Booster E1).
4. Choice of five metering patterns, including 16-zone evaluative, center-weighted average, 9% partial, 3.5% spot metering linked to each focusing point, and 2.3% fine spot metering.
5. Enhanced multiple-zone TTL flash sensor plus built-in flash exposure compensation control up to ± 3 steps in 1/3-step increments.
6. Silent drive mechanism for super-quiet film rewinding.
7. Improved and expanded custom functions for greatly enhanced operational flexibility, letting you customize many facets of the camera's operation to match your shooting style. New custom functions include:
 - Choice of silent or high-speed rewind
 - Mirror lock
 - Flash output reduction control
 - Ability to set shutter speeds and aperture values in 1-step, 1/2-step or 1/3-step increments
 - Ability to select individual focusing points with quick control dial
 - Ability to change AEB exposure order and prevent cancellation
8. Built-in eyepiece shutter.

The EOS-1 N family consists of the following three models in addition to the standard model:

- **EOS-1 N DP:** This model combines the BP-E1* AA-size battery pack with the EOS-1 N, allowing the user to switch between the standard 2CR5 lithium battery or AA-size batteries depending on the shooting situation. (Refer to page 93.)
- **EOS-1 N HS:** This model combines the Power Drive Booster E1* with the EOS-1 N, providing high-speed continuous shooting and increased shooting capacity. (Refer to page 96.)
- **EOS-1 N RS**:** This model features a non-moving, hard-coated new pellicle mirror which provides non-interrupted viewing through the viewfinder and rapid-fire continuous shooting at 10 frames/sec. Moreover, the camera's release time lag (the time between when the shutter button is pressed and when the exposure occurs) is reduced to a mere 0.006 sec. (Refer to page 100.)

* BP-E1 and Power Drive Booster E1 must be purchased separately in North America.

**The EOS-1 N RS is scheduled for availability in Spring 1995.

● General Precautions

- Before an important event such as a trip or wedding, be sure to test the camera to make sure it is operating correctly.
- The EOS-1 N will give optimum performance together with exclusively designed Canon EF lenses, flash and other Canon brand accessories. It is possible that the use of incompatible lenses or other accessories may result in unsatisfactory performance or damage to your EOS-1 N. We therefore suggest the use of Canon EF lenses and accessories. Damage to your Canon camera as a result of malfunction or improper connections caused by the use of incompatible products may void its warranty.

● Throughout this manual special precautions relating to the various camera operations are enclosed in boxes marked with the following symbols.



Cautionary measures to ensure proper camera use and prevent undesired results or malfunction.



Reference information for helping you gain maximum functionality from your camera.















Helpful hints for using your camera productively and with maximum efficiency.

- To keep your camera in top working condition, be sure to read the Camera Care and Precautions section on page 6.
- After reading this manual, store it in a convenient place that is quick and easy to access when necessary.

	Camera Care and Precautions6 1. Handling, Cleaning and Storage6 2. Liquid Crystal Display Information.....7
I Shooting Preparations and Basic Operation	<ul style="list-style-type: none"> ● Attaching the Strap13 1. Loading the Battery14 2. Checking the Battery Level (Film Shooting Capacity)15 3. Operating the Main Switch16 4. Setting and Adjusting Basic Functions .17
II Selecting the AF and Metering Modes	1. Selecting the Five Focusing Points (AF)29 <ul style="list-style-type: none"> ● Selecting a Focusing Point29 ● Focus Lock31 2. Selecting the AF Mode32 <ul style="list-style-type: none"> ● One-Shot Autofocus32
III Selecting the Shooting Mode	1. Shutter-priority AE [Tv].....49 2. Aperture-priority AE [Av]52 3. Depth-of-Field AE [DEP]55 <ul style="list-style-type: none"> ● Using Manual Focusing
IV Configuring the Camera	1. Manually Setting the Film Speed66 2. Changing the Film Winding Mode....67 <ul style="list-style-type: none"> ● Film Winding Automatic Gear Switching Function.....68 ● Maximum Continuous Shooting Speed in Different AF Modes
V Using Flash	1. Using EOS Dedicated Speedlites77 <ul style="list-style-type: none"> ● Automatic Flash Output Reduction Control77
VI Custom Functions	1. Setting and Resetting Custom Functions.....82 <ul style="list-style-type: none"> ● Setting a Custom Function.....82
	Additional Information for the EOS-1 N DP Model93 Additional Information for the EOS-1 N HS Model96

4 • New functions appearing on the EOS-1 N for the first time are indicated by an (**AF**). If you are already familiar with the operation of the EOS-1, you can quickly familiarize yourself with the EOS-1 N by just reading the text sections indicated by an (**AF**).

3. Blinking “bc” Display7	5. Camera Operation with a Low Battery8
4. Battery Information8	Nomenclature9
5. Lens Attachment18	● Removing Film25
● Removing the Lens18	● Removing Film in Mid-Roll ()25
6. Dioptric Adjustment19	9. Custom Functions25
7. Shutter Button Operation and Autofocus20	10. Program AE mode [P]26
8. Film Loading22	● Program Shift Function27
● AI Servo Autofocus33	● Remaining Frame Counter27
3. Difficult Subjects for Autofocus34	● Partial Metering ()38
4. Manual Focusing36	● Fine Spot Metering ()()39
● Full-time Manual Focusing with USM Lenses36	6. AE Lock40
5. Selecting the Metering Mode37	7. Exposure Compensation42
● Evaluative Metering ()38	8. Auto Exposure Bracketing [AEB]45
Point Selection Mode55	5. Bulb Exposure []61
● Using Automatic Focusing Point Selection Mode57	6. Multiple Exposures ()63
4. Manual Exposure [M]59	
(frames/sec.)68	5. Locking the Mirror Up ()72
3. Changing the Film Rewinding Mode ()69	6. Infrared Photography73
4. Using the Self-Timer ()70	7. Checking the Depth of Field74
● Using the Eyepiece Shutter ()71	8. Illuminating the LCD Panel74
2. Flash Exposure Compensation ()78	9. Resetting the Camera to Its Initial Settings75
● Speedlites Capable of Flash	Exposure Compensation79
● Resetting a Custom Function83	3. Using Non-dedicated Flash Equipment80
2. Custom Function Chart ()84	● Combined Use of Custom Functions F-5 and F-1192
Attaching the Standard Grip99	Program Line Characteristics108
Additional Information for the EOS-1 N RS Model100	Specifications109
Troubleshooting106	Quick Guide to EOS-1 N Functions...115

Camera Care and Precautions

1. Handling, Cleaning and Storage

- This camera is a high-precision instrument. Be careful not to drop it or subject it to shock.
- The Canon EOS-1 N has been designed for increased resistance to moisture. However, this camera is **not waterproof** and must therefore be handled with reasonable care. Keep the camera out of salt spray and protect it from excessive moisture. If used at the beach, clean it thoroughly afterward with a dry cloth. If dropped in water, contact an authorized Canon service facility.
- This camera contains high-precision circuits. Do not attempt to disassemble the camera yourself. Always take it to an authorized Canon service facility for repair.
- Do not touch the camera's electronic contacts with your fingers. Touching the contacts can cause corrosion and affect proper camera operation.
- After removing a lens from the camera, place it face down on a flat surface to avoid damaging the electronic contacts on the lens mount.
- Condensation is a problem when bringing cold equipment into a warm place. If the autofocus optics cloud over, accuracy may be seriously affected. Before entering a warm place, put equipment in a plastic bag so condensation forms on the outside of the bag.
- To remove dust from the lens, viewfinder eyepiece, mirror, focusing screen or film chamber, gently blow the dust away using a commercially-available bulb-type blower. Avoid directly touching any of these surfaces. Do not wipe the camera body or lens with any type of cleaner containing organic solvents. When further cleaning is necessary, consult your nearest Canon service center.
- The shutter curtain operates with extremely high precision and can be easily damaged if touched. When loading or unloading film, be careful not to touch the shutter curtain accidentally with your finger or the tip of the film. To remove dust from the shutter curtain or surrounding area, only use a blower and be careful not to blow air onto the curtain too strongly. Strongly blowing air onto the curtain may deform or damage it. Aerosol spray dust removers are not recommended for the shutter curtain.
- When storing the camera, wrap it in a clean, soft cloth and place it in a well-ventilated, cool, dry, dust-free place. Be sure to keep the camera out of direct sunlight, and away from "hot spots" such as the trunk or rear window shelf of a car. Avoid places where moth balls are used, and in extreme humidity, use a desiccant. To prevent corrosion, avoid storing the camera in a laboratory or other location where chemicals are used. Also, do not store the camera in a drawer or other non-ventilated place. Remove the battery if you do not expect to use the camera for about three weeks or longer. It is also recommended to take the camera out and release the shutter occasionally to prevent build up of mold or corrosion.

- A minute amount of battery power is used for the display even when the main switch is set to **■**. This does not affect the camera's shooting capacity (number of film rolls possible per battery).
- Carefully check the camera's operation after lengthy storage. When the camera has not been used for a long time, or before an important trip or shooting assignment, we recommend having the camera thoroughly tested at a Canon service center.

2. Liquid Crystal Display Information

The LCD panel uses liquid crystal to indicate camera settings. Due to the characteristics of the liquid crystal, the display may become difficult to read because of its life span which varies according to the condition of use. If this occurs, have it replaced at an authorized Canon service facility. Replacement is at the owner's expense in case of out of warranty term.

Liquid crystal may also respond relatively slowly in temperatures below 32°F/0°C. It may also darken in temperatures of around 140°F/60°C. The LCD panel will return when the temperature returns to normal.

3. Blinking "bc" Display

There are two conditions in which the blinking "bc" will appear in the LCD panel: (1) when the battery is nearly exhausted or (2) when the camera's self-test process detects an internal malfunction. If the blinking "bc" indicator appears, perform the following operations:

1. Press the battery check button to check the battery level. If the battery level is low, replace the battery with a new one.
2. If the indicator shows a sufficient battery level, remove the battery, wipe the battery terminals and reload it.
3. Release the shutter once.

If the "bc" display stops blinking, the problem is corrected and you can continue using the camera normally. If the blinking does not stop, the camera needs to be examined by an authorized Canon service facility.

Camera Care and Precautions

4. Battery Information

This camera requires battery power for operation. Always check the battery at the following times:

1. When loading a new battery
 2. After lengthy storage
 3. If the shutter will not release
 4. In cold weather
 5. Before an important shooting assignment
- Wipe the battery terminals with a clean, dry cloth to ensure proper contact.
 - The battery may explode or cause burns if disassembled, recharged, shorted, exposed to high temperatures, or disposed of in fire. Be sure to observe all precautions indicated on the battery package. Always keep batteries out of the reach of children.
 - Lithium battery performance deteriorates slightly in temperatures below 0°C/32°F. Keep the camera and especially a spare battery close to your body or in an inside pocket to keep it warm until use.

5. Camera Operation with a Low Battery

Even if the battery indicator blinks or does not appear in the LCD panel during battery check, exposure will be correct as long as the shutter releases. When the battery power drops below a certain level, film advance and rewinding stop operating and "bc" blinks in the display. Film winding automatically resumes after a new battery is loaded. To resume rewinding, press the film rewind button ().

Nomenclature

- Page numbers of sections related to each component are indicated in parentheses.

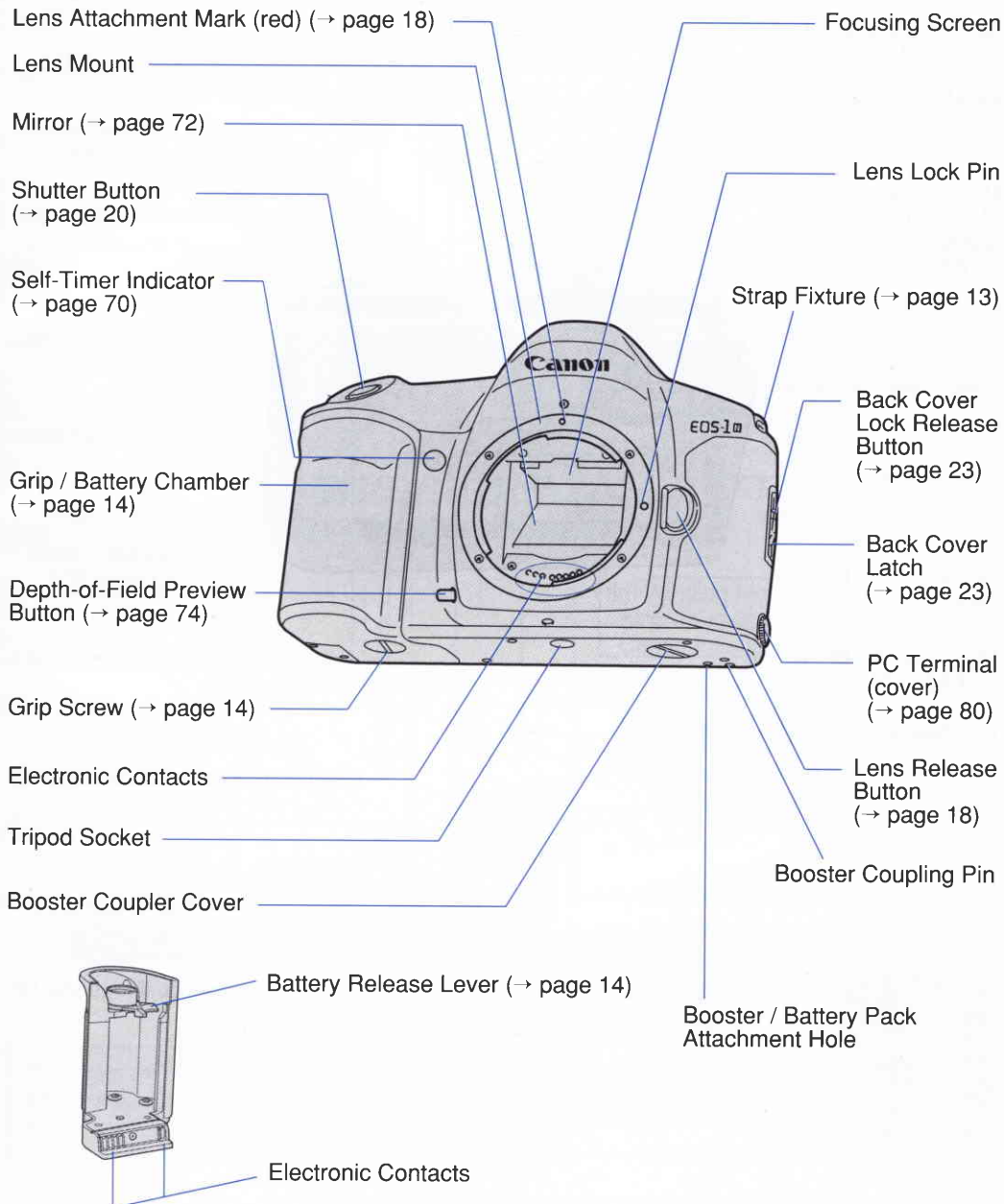

Nomenclature

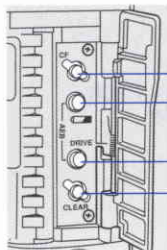
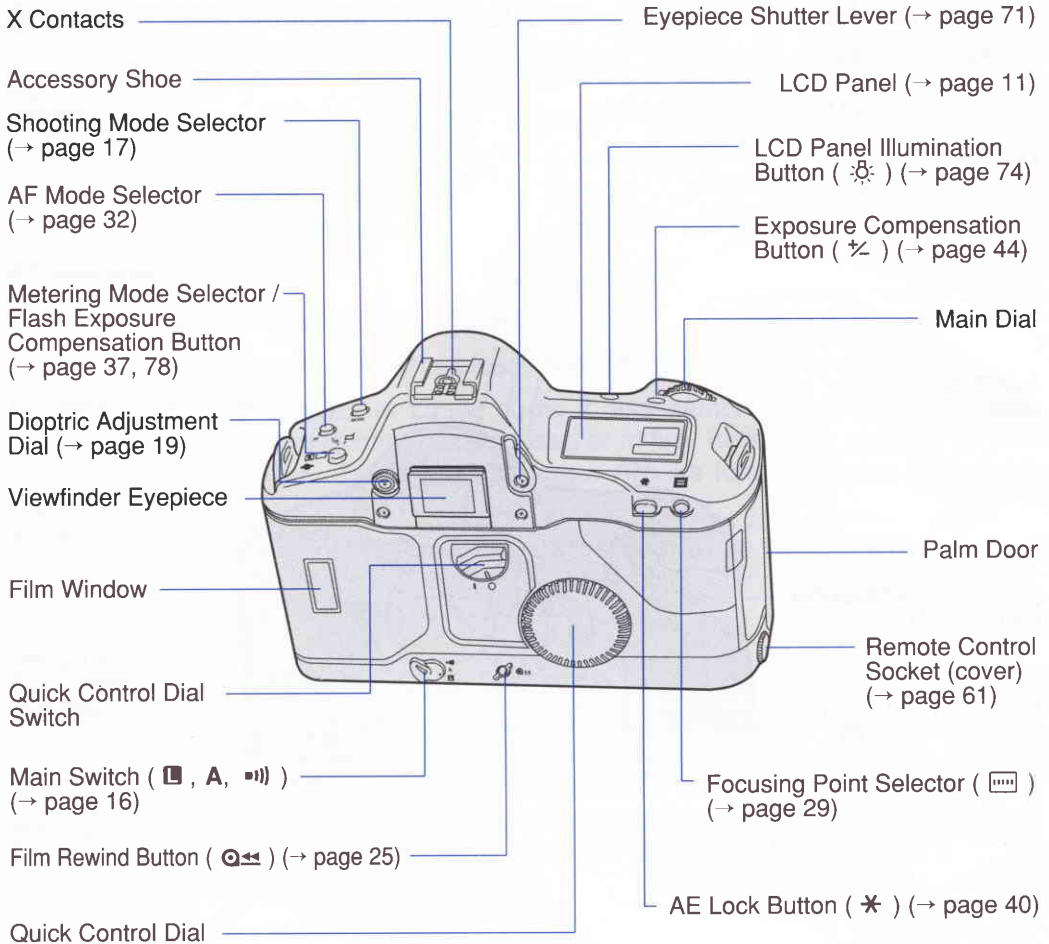

- Custom Function Set Button (→ page 82)
- Battery Check Button (BATT) (→ page 15)
- Film Winding Mode Selector (blue) (→ page 67)
- Clear Button (white) (→ page 75)



Eyecup Ec II (→ page 19)

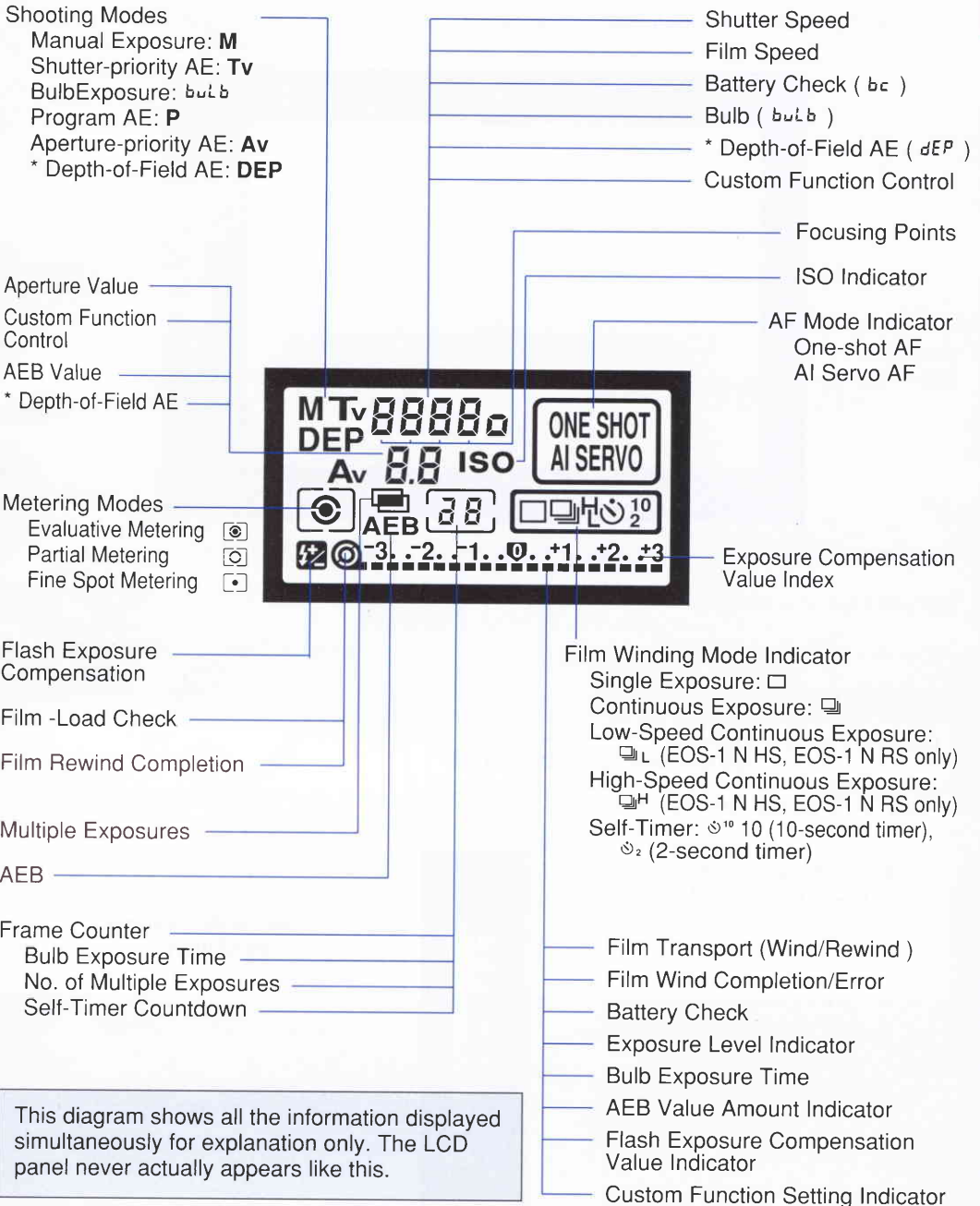

This diagram shows all the information displayed simultaneously for explanation only. The LCD panel never actually appears like this.

* Not available on the EOS-1 N RS.

Nomenclature

Focusing Points/Spot Metering Position Indicators

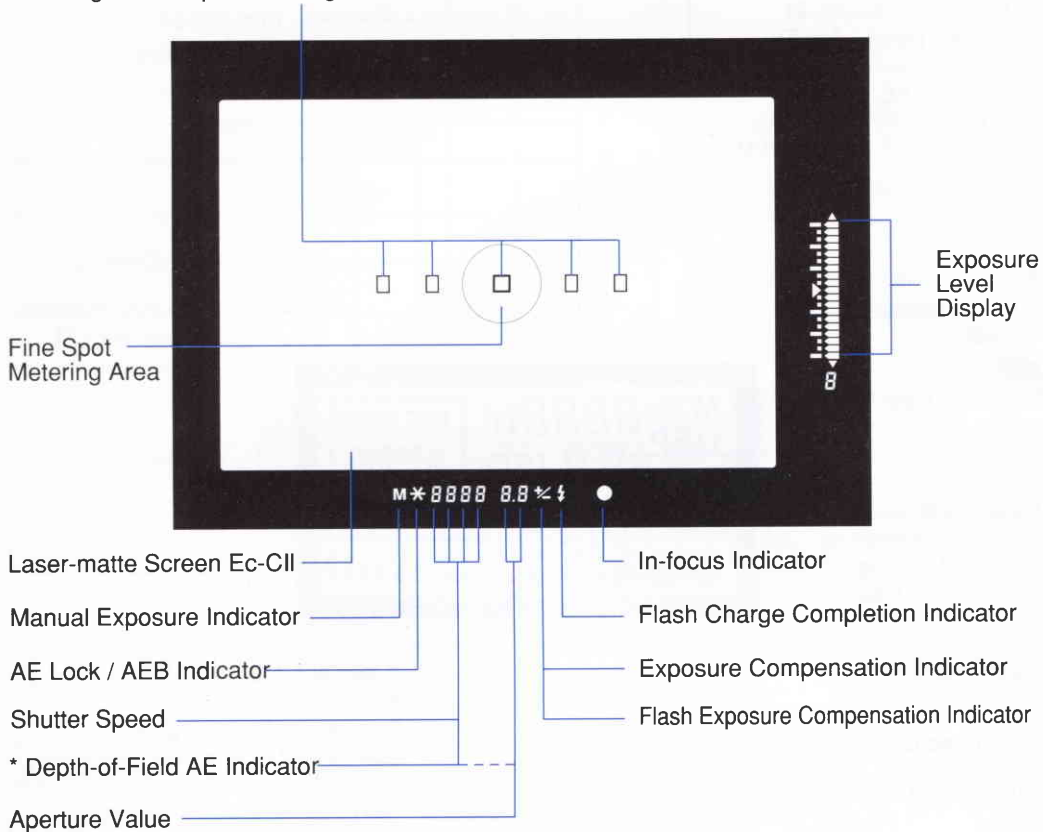

Exposure Step Indicator
(□: 1-stop, □: 1/3-stop)

Correct Exposure Indicator

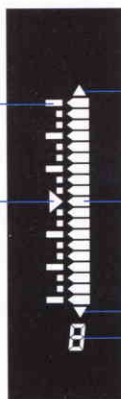

Overexposure Indicator
(+3 stops or more)

Exposure Level Indicator

Underexposure Indicator
(-3 stops or more)

Remaining Frame Counter
(F: more than 9, 9~0)

* Not available on the EOS-1 N RS.

I Shooting Preparations and Basic Operation

This section explains the preparations necessary to set up the camera before use, as well as the basic operation of the camera.

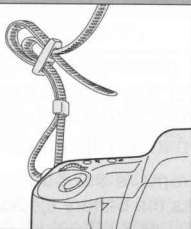

● Attaching the Strap

Thread the ends of the strap through the strap fixtures as shown. Pull firmly on the strap to make sure it is held securely by the buckles.

1. Loading the Battery

This camera operates on a 6-volt, 2CR5 lithium battery, housed in the grip.

- Refer to page 93 for additional information on the batteries of the EOS-1 N DP model and page 96 for the EOS-1 N HS model and the EOS-1 N RS model.

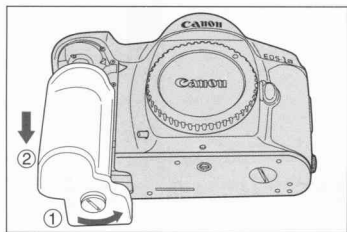

- 1 Using a coin or similar object, turn the grip screw counterclockwise to loosen the grip. The screw cannot be removed from the grip.
- 2 Slide the grip down to remove.

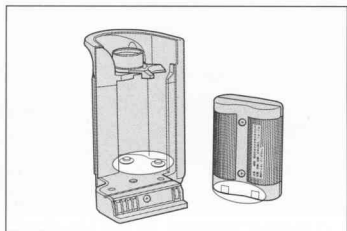

- 3 Load the battery upside down into the grip so that its terminals align with the terminals in the battery compartment.

- The battery label should be facing toward you and the terminals should be on the bottom after the battery is installed.

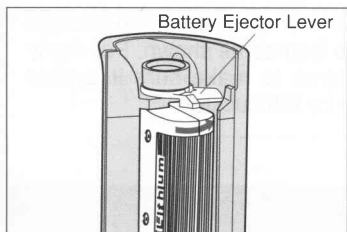

- 4 After placing the battery into the front of the compartment, push it all the way into the compartment as shown in the illustration.

- To remove the battery from the grip, press the battery ejector lever.

- 5 Replace the grip on the camera and turn the screw clockwise to firmly lock it in place.



Lithium batteries may not be available in some areas. Be sure to take along a spare when going on a trip or embarking on an important shooting assignment.

2. Checking the Battery Level

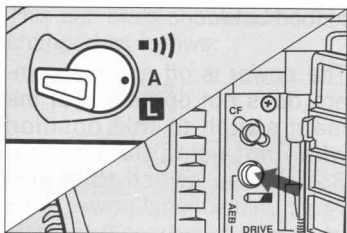

- 1 Set the main switch to "A".
- 2 Open the palm door and press the battery check button.

- 3 The battery check indicator (----) is displayed in the LCD panel. The battery level is indicated as follows:

Fig. 1: Battery power sufficient.

Fig. 2: Have a new spare battery handy.

Fig. 3: (blinking) The battery will soon be exhausted.

Fig. 4: (no display) Replace the battery with a new one.

bc (blinking): Refer to page 7.

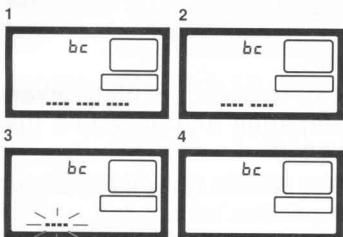

2CR5 Lithium Battery Shooting Capacity

Temperature	Shooting capacity (rolls)
Normal (+20°C/68°F)	75 (50)
Low (-20°C/-4°F)	12 (8)

- Data based on Canon's Standard Test Method using a new battery, EF50mm f/1.4 USM lens and 24-exposure film. Values in parentheses are for 36-exposure film.
- Repeated autofocus operation without taking any pictures will reduce the overall shooting capacity.
- Refer to page 93 for the shooting capacity of the EOS-1 N DP model, page 96 for the EOS-1 N HS model and page 100 for the EOS-1 N RS model.



- If nothing appears on the LCD panel when the main switch is set to "A", the battery may be inserted backwards. Remove the battery and reinsert it correctly.
- Exposure will be okay as long as the shutter releases.

3. Operating the Main Switch

The main switch has three settings, as described below:

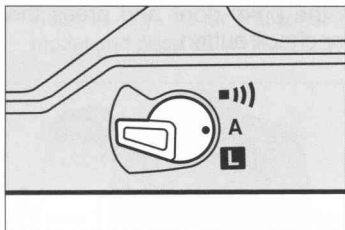

- L** : The power is off and the camera does not operate. Set the main switch to this position when not using the camera. Setting the switch to **L** prevents unintentional power drain which can be caused by objects pressing against the shutter button during transport or storage.
- A** : Set to this position when preparing and operating the camera.
- : This position is the same as the **A** position except that a beep sound is emitted when the subject is focused in One-shot AF or manual focusing mode.

● EOS-1 N RS Main Switch

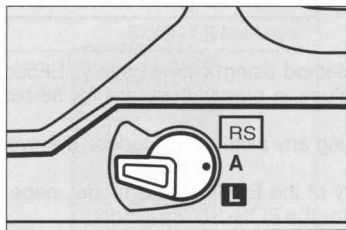

- L** : Turns off the camera and makes it inoperational.
- A** : Turns on the camera and makes it operational.
- RS** : Same as “**A**” except that the RS (Rapid Shot) mode is also set. This enables a continuous shooting speed of about 10 frames per second with a shutter release time lag of 0.006 sec.

4. Setting and Adjusting Basic Functions

This camera's shooting mode, AF mode and metering mode are set and changed as follows:

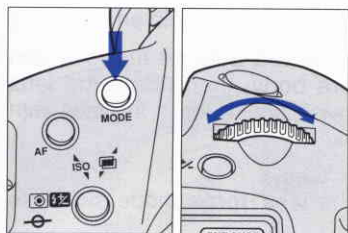

- 1 Set the main switch to "A".
- 2 Press the shooting mode selector (or AF mode selector or metering mode selector) and hold it down while turning the main dial to the left or right until the desired setting appears in the LCD panel.
- 3 Release the shooting mode selector (or AF mode selector or metering mode selector).

To change the film winding mode, use the following procedure:

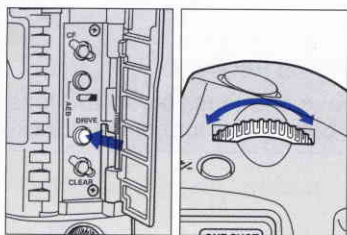

- 1 Set the main switch to "A".
- 2 Open the palm door and press the film winding mode selector.
- 3 Turn the main dial to the left or right until the desired setting appears in the LCD panel.
- 4 The setting is completed when the shutter button is pressed halfway or six seconds elapse.

Pressing a button and turning a dial are the basic procedures for setting most camera functions. Some functions require that two buttons be held down simultaneously while turning the main dial. Detailed instructions are provided where necessary throughout this instruction book.

5. Lens Attachment

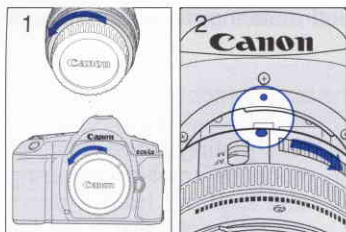

1 Remove the lens' rear dust cap and the camera's body cap by turning them counterclockwise.

2 Align the red dots on the lens and camera body, then rotate the lens clockwise until it locks in place with a click.

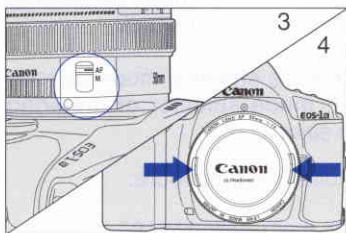

3 Set the lens' focus mode switch to "AF".

- Autofocus is not possible when the switch is set to "M".
- During autofocusing, do not touch the rotating part of the lens.

4 Remove the front lens cap.

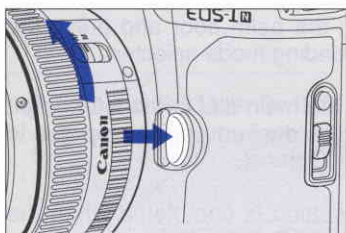

● Removing the Lens

To remove the lens, press the lens release button and turn counterclockwise.



When the lens is removed from the camera, place it face down on a stable surface to prevent damage to the electronic contacts.



6. Dioptric Adjustment

The viewfinder has a built-in dioptic adjustment mechanism that lets you adjust the eyesight correction to achieve a sharp viewfinder image. This also allows near- or far-sighted users to take pictures without wearing glasses. The diopter can be adjusted within a range of $-3 \sim +1$ dpt.

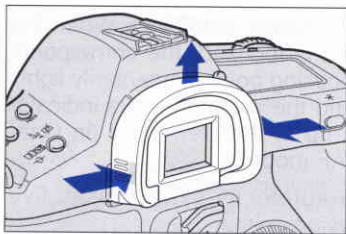

- 1 Press inward on both sides (nonslip grip sections) of the eyecup frame.
- 2 While pressing in on the sides, slide the eyecup frame up to remove.

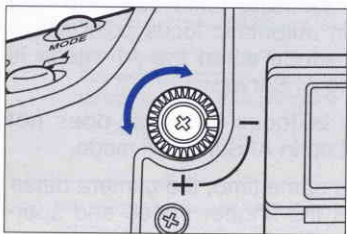

- 3 Look into the viewfinder and turn the dioptic adjustment dial in either direction until the five focusing points or the fine spot metering area mark appear sharp.

- The diagram shows the dial in the standard position (no compensation: -1 dpt).

- 4 Reattach the eyecup to the camera.



The adjustment range is from -3 dpt to $+1$ dpt (diopter). For adjustment exceeding this range, use one of the optionally available Dioptic Adjustment Lenses.

7. Shutter Button Operation and Autofocus

The shutter button has a two step construction. Press halfway (to the first step) to activate focusing and metering, and press completely (to the second step) to release the shutter and make the exposure.

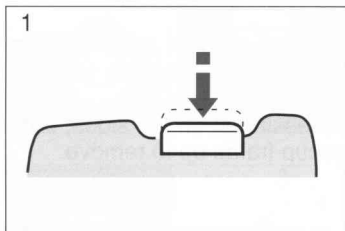

In-focus indicator

1. Pressing Halfway

1) This activates autofocus. When the subject is focused, the corresponding focusing point momentarily lights red and the green in-focus indicator lights up in the viewfinder (in One-shot AF mode).

- The autofocus system uses five focusing points.
- The focusing point does not light up in automatic focus point selection mode when the AF mode is set to AI Servo.
- The in-focus indicator does not light up in AI Servo AF mode.

2) At the same time, the camera determines the shutter speed and aperture value combination (exposure value), and the results are displayed in the LCD panel and viewfinder. If you remove your finger from the shutter button, a timer operates to continuously display the exposure settings for six seconds.

2

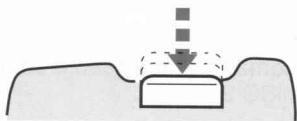

2. Pressing Completely

This releases the shutter and takes the picture, then advances the film. The LCD panel's frame counter displays the frame number.

- Viewfinder data is extinguished during exposure.



- If the camera moves at the instant the shutter is released, the motion during exposure may cause an unsharp picture. This occurrence, called "camera shake," can be prevented by following these guidelines:
 - (1) Hold the camera with your right hand and the lens with your left hand firmly so that they do not move when you take the picture.
 - (2) Gently press the shutter button from the halfway position to the fully-pressed position with the fat part of your index finger. The trick to keeping the camera still when taking a picture is to press the shutter button by gently squeezing the camera with your right hand.

- The shutter button stroke (height) can be changed according to your preference by taking the camera to an authorized Canon service center (modification will be at the owner's expense).

8. Film Loading

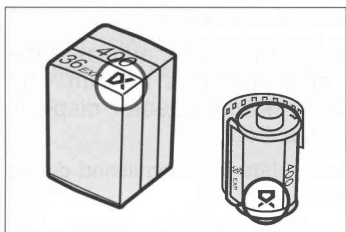

When DX film is loaded, the film speed is set automatically according to the DX code on the film cartridge.

- The automatic film speed setting range is ISO 25~5000.
- If non-DX film is loaded, the ISO indicator and the numbers for the previously-set film speed blink in the LCD panel. Set the appropriate film speed according to instructions in “1. Manually Setting the Film Speed” on page 66.
- To set a film speed other than the automatically-set DX film speed, see “1. Manually Setting the Film Speed” on page 66.
- The currently set film speed can be checked by simultaneously pressing the AF mode selector and metering mode selector. The “ISO” indicator and the currently set film speed are displayed in the LCD panel.

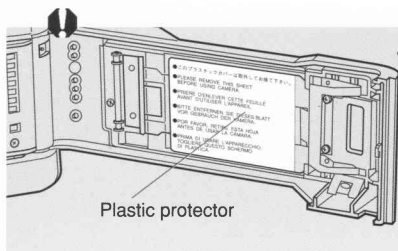
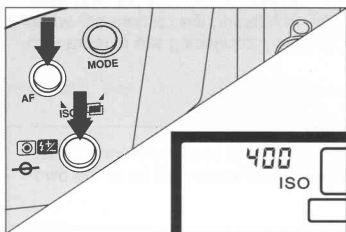

- Before loading film for the first time, be sure to remove the plastic protector from inside the back cover. If the plastic protector is left inside the camera while taking pictures, the characters printed on the plastic may appear in the exposed image.

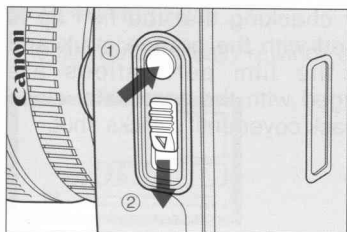

- 1 Set the main switch to "A".
- 2 Open the back cover by using your thumb to press the back cover lock release button while sliding the latch down.

- If you find it difficult to perform both operations with one finger, use one finger to press the back cover release button and another finger to operate the latch.

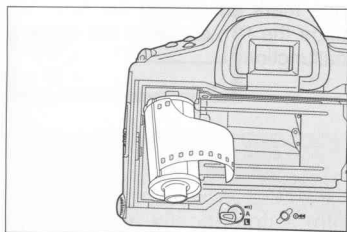

- 3 Insert the film cartridge at a slant with the flat end facing up and the bottom end entering the camera first.

- 4 Carefully pull the film tip across until it reaches the orange mark.

- Hold down the film cartridge while aligning the film to prevent slack.

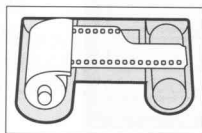
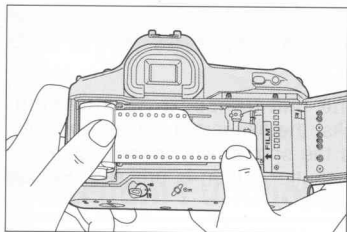

CORRECT

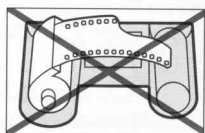

WRONG

- If you pull out too much film, wind the excess back into the cartridge.



The shutter curtain operates with extremely high precision and can be easily damaged if touched. When loading or unloading film, **BE CAREFUL** not to touch the shutter curtain accidentally with your finger or the tip of the film.

Film Loading

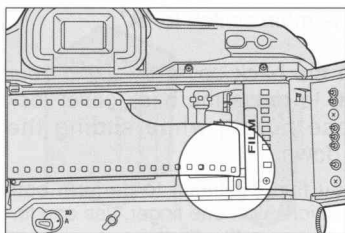

CORRECT

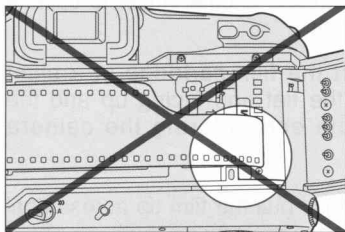

WRONG

- 5 After checking that the film tip is aligned with the orange mark and that the film perforations are engaged with the sprockets, close the back cover until it clicks shut.

- **DO NOT** pull the film tip past the orange mark. If the film tip passes the orange mark, advancing the film may damage the film or cause the camera to malfunction.

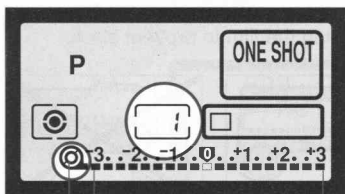

Film transport (wind/rewind)

Film-load check symbol

- 6 The film automatically advances to the first frame, the frame counter shows "1" and the film-load check symbol is displayed in the LCD panel.

- If the film transport (wind/rewind) blinks, the film is not loaded correctly, and the shutter will not release when the shutter button is pressed. Reload the film.



Using film which has been exposed to high humidity may cause the film perforations to tear when the camera advances the film. In humid locations, do not remove the film from its original sealed package until immediately prior to loading it into the camera.

● Removing Film

The film automatically rewinds at the end of the roll.

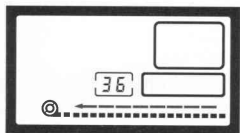

1 When rewinding starts, the film rewind indicator moves from right to left to show that the film is rewinding. At the same time, the LCD panel's frame counter counts down the number of frames.

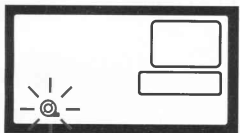

2 Automatic rewind stops when completed. Film rewind completion "⊙" blinks in the LCD panel to indicate that you can now safely open the back cover and remove the film.

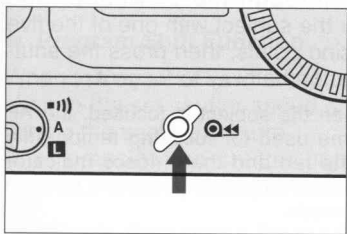

● Removing Film in Mid-Roll (⊙⏪)

To rewind the film in mid-roll, press the film rewind button (⊙⏪). The film immediately starts rewinding.

9. Custom Functions

Custom function settings let you modify the camera's basic functions to match your shooting style. Custom function numbers appear in various sections throughout this instruction book, indicating that the function being described can be further modified by changing the relevant custom function setting. For details on the types of custom functions available and how to change them, refer to the "VI Custom Functions" section starting on page 81.

10. Program AE mode [P]

In Program AE mode the camera automatically sets the shutter speed and aperture value according to the subject brightness. This mode allows anyone to start taking pictures quickly without worrying about exposure settings. Five focusing points provide a wide focusing area, making it easy to try out various picture compositions.

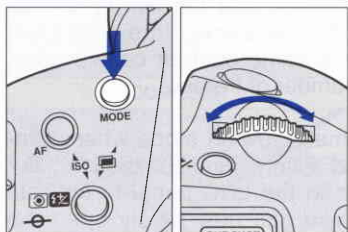

- 1 Turn on the main switch.
- 2 Press the shooting mode selector while turning the main dial until "P" appears in the LCD panel.

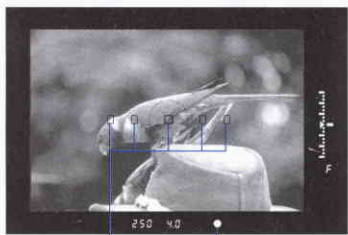

Focusing points In-focus Indicator

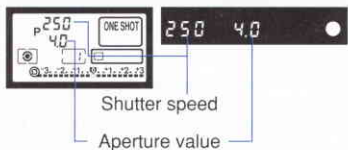

Shutter speed
Aperture value

- 3 Look through the viewfinder and cover the subject with one of the five focusing points, then press the shutter button halfway to focus it.

- When the subject is focused, the AF frame used for focusing temporarily lights red and the in-focus indicator lights up in the viewfinder in One-shot AF mode.
- If the in-focus indicator blinks, the autofocus system cannot focus the subject and the shutter will not release. Refer to "4. Manual Focusing" on page 36 for instructions on how to focus the subject manually.
- Exposure settings are displayed in the LCD panel and viewfinder.

- 4 After confirming that the exposure settings are not blinking, press the shutter button completely to take the picture.

[Exposure Warnings]

- If a shutter speed of 30" and the maximum aperture value blink in the display, the subject is too dark. Switch to flash photography, referring to "V. Using Flash" on page 76.



- If a shutter speed of 8000 and the minimum aperture value blink in the display, the subject is too bright. Attach a neutral density (ND) filter to the lens.



● Six-Second Timer

When you release the shutter button after pressing it halfway, the LCD panel and viewfinder displays remain active for six seconds.

● Program Shift Function

When taking pictures in Program AE mode, you can "shift the program" to change the set shutter speed and aperture value combination while maintaining the same exposure.

After pressing the shutter button halfway, turn the main dial until the desired shutter speed/aperture value combination is displayed.

● Remaining Frame Counter

When nine frames or less remain on the roll, the number of remaining frames is displayed in the viewfinder below the exposure level display. "F" indicates that 10 or more frames remain on the roll. When less than 10 frames remain, the display counts down the frames in descending order: 9, 8 ... 2, 1.

- Non-DX films are identified as 36-exposure rolls, and the remaining frame counter operates accordingly.



Remaining frame counter

II Selecting the AF and Metering Modes

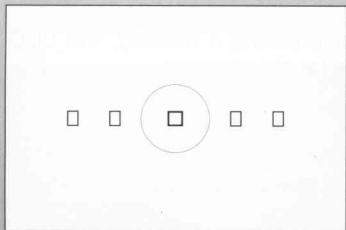

This camera's wide-zone autofocus system lets you freely select from five focusing points, allowing you to keep the scene composed as desired while concentrating on the subject. Also, a rich selection of exposure options lets you select the metering mode appropriate for the subject or shooting situation, and flexible exposure compensation capabilities let you fine tune the exposure in real time.

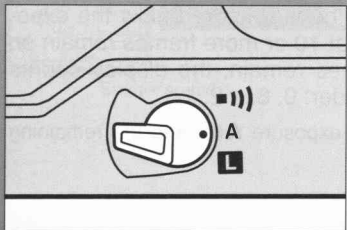

- First make sure the camera's main switch is set to "A" or "M" "

1. Selecting the Five Focusing Points

This camera incorporates a high-precision AF sensor called Multi-BASIS (Multi Base-Stored Image Sensor), equipped with five focusing points for wide autofocusing coverage.

You can freely select any of the focusing points to compose the scene as desired, or you can let the camera select the focusing point for you (automatic focusing selection mode).

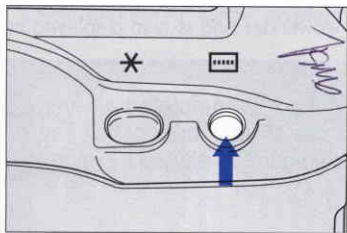

● Selecting a Focusing Point

- 1 Press the focusing point selector ().
- 2 The currently selected focusing point lights red in the viewfinder and the focusing point indicator is displayed in the LCD panel.

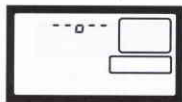

- All five focusing points light up in the viewfinder and LCD panel when the camera is set for automatic focusing point selection mode.

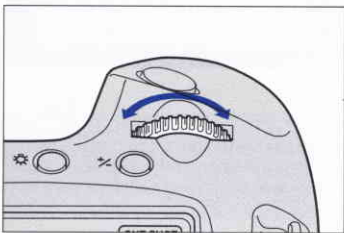

- 3 Turn the main dial to select the desired focusing point.



● Automatic Focusing Point Selection Mode

- The camera automatically selects an individual focusing point after evaluating all 5 points simultaneously.
- In One-shot AF mode, the system usually gives priority to the closest reliable subject.
- In AI Servo AF mode, the system always gives priority to the central (cross-type) focusing point for the first exposure. (For more information, refer to page 33.)

Selecting the Five Focusing Points

- Turning the main dial selects the focusing points in the following order: automatic focusing point selection (all five focusing points are displayed) ↔ far left ↔ left center ↔ center ↔ right center ↔ far right.



- The selected focusing point lights red in the viewfinder and is also displayed in the LCD panel.

4 The setting is completed when you press the shutter button halfway or after six seconds elapse.

Custom Function *F 12*

(Refer to pages 88–89)

Prohibits superimposed focusing points in the viewfinder.

Custom Function *F 11*

(Refer to pages 90–91)

This function lets you select the focusing point using the exposure compensation button (instead of the focusing point selector ()) in combination with the main dial, or by only turning the quick control dial.

● Focus Lock

When you want to compose a scene with the main subject positioned out of the zone covered by the five focusing points, follow the procedure below to first lock the focus on the subject before composing the scene and taking the picture.

- The focus lock function is available only in One-shot AF mode. (Refer to “2. Selecting the AF Mode” on page 32.)

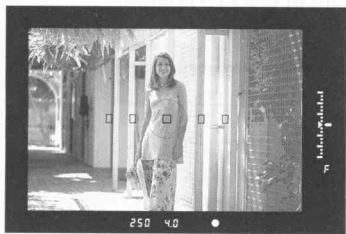

- 1 Cover the subject with the selected focusing point and press the shutter button halfway to focus the subject.



- 2 Keeping the shutter pressed halfway, recompose the picture as desired.
- 3 Press the shutter button completely to take the picture.



The exposure settings are determined when the subject is focused. If the subject brightness changes after you lock the focus, the subject may not be properly exposed. For information on different types of metering, refer to page 37.

Custom Function F-4

(Refer to pages 84–85)

This custom function lets you lock the exposure with the shutter button instead of the AE lock button (*). Pressing the AE lock button activates autofocus.

2. Selecting the AF Mode

Two types of autofocus are available: One-shot AF and AI Servo AF. Select the mode most appropriate for the subject and shooting situation.

- To use the camera's AF modes, the lens' focus mode switch must be set to "AF".

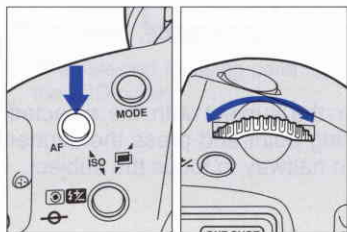

- 1 While pressing the AF mode selector, turn the main dial to the left or right until the desired AF mode appears in the LCD panel.



- 2 Release the AF mode selector.

● One-Shot AF

Use this mode with stationary subjects. The shutter will not release if the subject is not in focus, preventing out-of-focus shots. When the shutter button is pressed halfway and the subject is focused, the corresponding focusing point lights red in the viewfinder, and the in-focus indicator (●) lights up in the viewfinder.

- In evaluative metering mode, the shutter speed and aperture value are determined at this time, and by keeping the shutter button pressed halfway, the focus and exposure settings remain locked, allowing you to recompose the picture as desired.

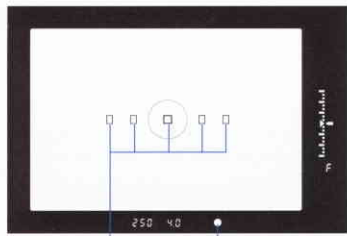
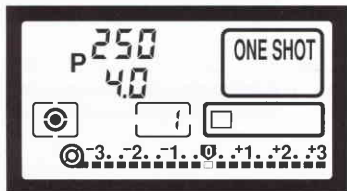

Focusing points

In-focus Indicator



The shutter will not release if the in-focus indicator is blinking. Try refocusing the subject on an alternate subject with higher contrast at approximately the same distance, or use manual focusing (refer to "3. Difficult Subjects for Autofocus" on page 34).

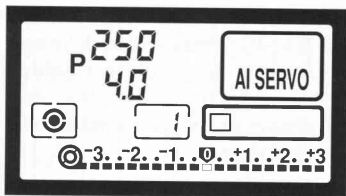

● AI Servo AF

Use this mode when taking pictures of moving subjects. The lens focuses the subject continuously while the shutter button is pressed halfway. AI Servo's predictive focus control* can track subjects moving toward or away from the camera. Exposure is determined immediately before the shutter is released.



- In AI Servo AF mode, the viewfinder's in-focus indicator does not light up and the beeper does not beep even when the subject is in focus.
- The in-focus indicator blinks if the subject cannot be focused.
- Focus lock cannot be used in this mode, but autofocus can be temporarily suspended through Custom Function 4-2 (refer to pages 86–87).

* Predictive focus control

Predictive focus continuously measures the distance and speed of a subject that is moving at a relatively constant velocity, and then predicts the subject position so that the subject will be sharply focused at the instant of exposure.

When using a manually selected focusing point, it is used for predictive focusing and lights red in the viewfinder.

In automatic focusing point selection mode, cover the subject with the center focusing point for initial focusing. After that, even if the subject moves to a different focusing point, the camera's predictive focus function will continue to track the subject as long as it is covered by one of the focusing points. The focusing point does not light up.

Custom Function *F-4*

(Refer to pages 86–87)

In AI Servo AF mode with predictive focusing (used for sports photography, etc.), this function lets you momentarily lock the focus using the AE lock button.

Custom Function *F-11*

(Refer to pages 90–91)

In AI Servo AF mode, this function lets you select the focusing point with the quick control dial to manually track the moving subject.

3. Difficult Subjects for Autofocus

This camera's autofocus system is very accurate and can quickly focus most subjects with the high-precision Multi-BASIS (Base-Stored Image Sensor) AF sensor equipped with five focusing points as shown below. However, the system may have difficulty focusing the subjects listed below. When autofocus is impossible, the green in-focus indicator will blink in the viewfinder.

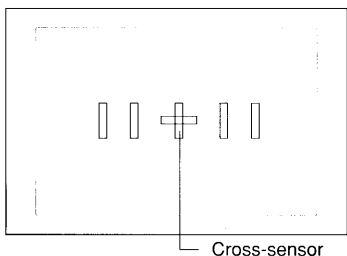

- Position of individual sensor of BASIS

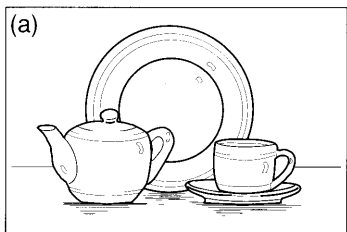

- (a) Low contrast subjects (misty scenes, light-colored or white objects)
- (b) Subjects in extremely low-light situations (a dark room, night scenes)
- (c) Subjects in extremely strong backlight, or with bright spectral reflections (shiny metal, snow, ice, surface of a lake)
- (d) Subjects with an object in front of them (caged zoo animals)
- (e) Subjects having generally horizontal patterns (only when using the center focusing point, when using lenses with maximum aperture smaller than $f/2.8$)
- (f) Subjects having generally vertical patterns (only when using focusing points other than the center)

Focus these subjects as follows:

- 1) Particularly with subjects such as (a), focus on a substitute subject at the same distance from the camera as your main subject, then recompose the picture using the focus lock function.
- 2) In the case of (e), there is no problem when using a lens with a maximum aperture of $f/2.8$ or larger (except the EF50mm $f/2.5$ Compact Macro or EF28-80mm $f/2.8-4L$) because the camera's central cross-sensor activates to detect horizontal lines. However, when using a lens with a maximum aperture smaller than $f/2.8$, we recommend to use the focusing points other than the center that

Difficult Subjects for Autofocus



have vertical sensors, focus the subject, then recompose the picture using the focus lock function.

- 3) In the case of (f), use the center focusing point which has a horizontal sensor, focus the subject, then recompose the picture using the focus lock function.
- 4) Set the lens' focus mode switch to "M" and manually focus the subject.
 - See "4. Manual Focusing" on page 36 for manual focusing instructions.

4. Manual Focusing

Use manual focusing when the subject is difficult to focus with the camera's autofocus system, or when you need to control the focus for alternative focus effects.

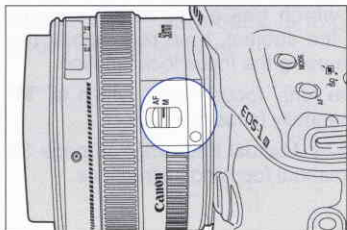

1 Set the lens' focus mode switch to "M".

- The AF mode display is extinguished in the LCD panel.

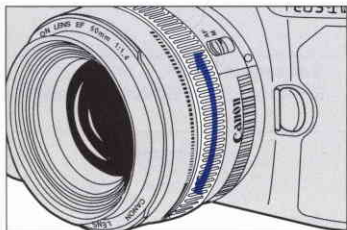

2 While pressing the shutter button halfway and looking through the viewfinder, turn the lens' manual focusing ring until the subject appears sharp.

- When the focus mode is switched from "AF" to "M", the focusing point and in-focus indicator in the viewfinder light when the subject is in focus.

● Full-time Manual Focusing with USM (Ultrasonic Motor) Lenses

USM lenses are equipped with a full-time manual focusing function that lets you immediately manually adjust the focus after autofocusing is completed to achieve the desired effect. Use this function in One-shot AF mode.

- This method of focus adjustment cannot be used if your USM lens does not have a distance scale.

Custom Function F-7

(Refer to pages 86–87)

When using a USM lens equipped with an electronic manual focusing system, setting this custom function will allow manual focusing only when the lens' focus mode switch is set to "M".

5. Selecting the Metering Mode

Three metering modes are available: evaluative metering (☉), partial metering (☐) and fine spot metering (●). Center-weighted average metering as well as spot metering linked to the focusing points can also be set with the corresponding custom function. In all metering modes, pressing the shutter button halfway activates the built-in metering system and determines the exposure.

Whether outdoors, indoors, at the sea or in the mountains, there is an infinite number of lighting conditions and subject types. Select the metering mode best suited for each subject.

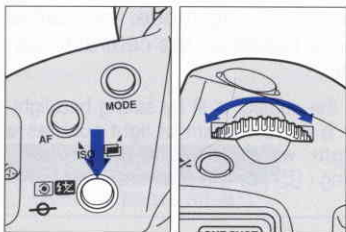

- 1 While pressing the metering mode selector, turn the main dial to the left or right until the desired metering mode indicator appears in the LCD panel.



- The metering mode changes in the cyclical sequence shown above.

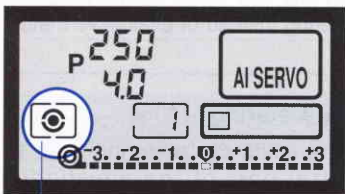

Metering mode indicator

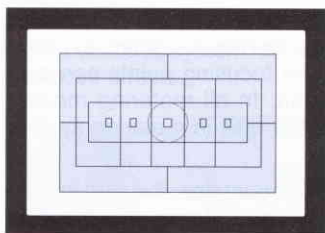

- 2 Release the metering mode selector.

Selecting the Metering Mode



● Evaluative Metering ()

Use this mode for general subjects and backlit scenes. By dividing the viewfinder into 16 metering zones linked with the five focusing points, the camera evaluates factors such as subject size, position (based on the focusing point in use), brightness, background, front lighting and back lighting to determine the best exposure setting. In manual focusing mode, evaluative metering is based on the central focusing point.

- When the subject is lit by strong backlighting or a narrow beam of light such as a spotlight, we recommend using partial metering () or fine spot metering ().

Custom Function *F-B*

(Refer to pages 88–89)

This function lets you select center-weighted average metering instead of evaluative metering ().

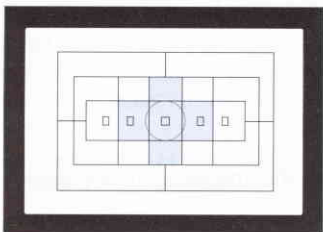

● Partial Metering ()

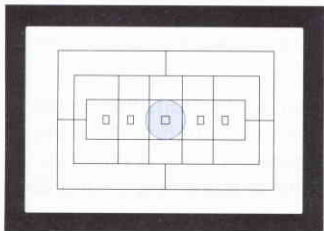

This mode limits the metering area to the central part of the viewfinder (approx. 9% of the image area). Select this mode when the subject is backlit or positioned near a strong light source.

Selecting the Metering Mode



● Fine Spot Metering ()

This mode limits the metering area to the center of the viewfinder as defined by the fine spot metering mark (approx. 2.3% of the image area). Use this mode when you need an accurate exposure reading of a specific subject area.

- In continuous shooting mode () or high-speed continuous shooting mode with the Power Drive Booster E1 ( L ,  H), the exposure value determined for the first frame is also used for the second and consecutive exposures.

Custom Function F 13

(Refer to pages 90–91)

This function lets you select spot metering linked to the focusing points. Metering is limited to the area of the manually selected focusing point (approx. 3.5% of the viewfinder image area).



In One-shot AF mode, exposure setting is locked during continuous shooting, but the AE lock indicator “* ” does not light in the viewfinder.

6. AE Lock

The EOS-1 N's evaluative metering system is coupled to the five focusing points. It controls the exposure according to the subject's position, based on the focusing point in use.

If you want to determine the exposure independently from the focusing operation, use AE lock. Use it when you also want to change the composition of the picture after determining the exposure. AE lock is effective for backlit subjects and other situations where there is extremely strong contrast between the subject and background.

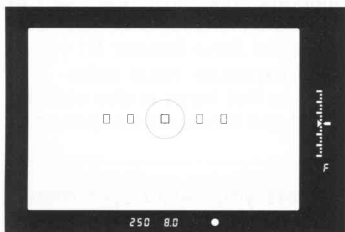

1 Focus the subject that you want to measure with the camera's metering system.

- The exposure values are displayed in the viewfinder and LCD panel.

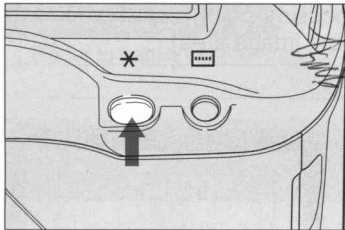

2 Press the AE lock button (*).

- “ * ” lights in the viewfinder to indicate that the AE lock is set. When you release the AE lock button (*), the metering timer is activated and the exposure remains locked for six seconds.
- Pressing the AE lock button (*) again renews the locked exposure setting.
- AE lock is canceled six seconds after the AE lock indicator (*) lights in the viewfinder display, or whenever you press the AF mode selector, metering mode selector, shooting mode selector or focusing point selector.



To accurately meter a specific subject area with the AE lock function, we recommend using partial metering or fine spot metering. Place the subject in the center of the viewfinder when activating AE lock.

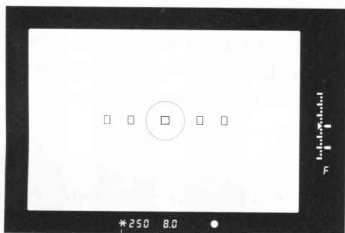

AE lock indicator

3 Refocus the subject, change the composition as desired, and take the picture.

- When you change the scene composition, the difference between the locked exposure value and the continuously metered exposure value is displayed in the viewfinder in real-time.



AE lock exposure value

Current metered exposure value

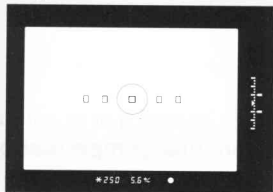

If you use AE lock to register a shadow reading of your subject and then change the scene composition to read a highlight area (or vice versa), you can then use exposure compensation (refer to page 42) to adjust the exposure level based on the brightness range of the scene.

Custom Function F-4

(Refer to pages 84–85)

This custom function lets you lock the exposure with the shutter button instead of the AE lock button (*). Pressing the AE lock button activates autofocus.



- When using One-shot AF together with Evaluative metering, the exposure reading is automatically locked when autofocus is completed after pressing the shutter button halfway.
- When using One-shot AF together with Fine Spot or Partial metering, exposure setting is locked **only** during continuous shooting.

7. Exposure Compensation

When taking pictures in an AE shooting mode, you can compensate the exposure according to the subject conditions either by using the quick control dial while looking through the viewfinder or by using the exposure compensation button and the main dial. Exposure can be compensated up to ± 3 stops in 1/3-stop increments.

Custom Function F-5

(Refer to pages 86–87)

In addition to 1/3-stop increments, the exposure compensation amount can also be input in 1/2-stop increments.

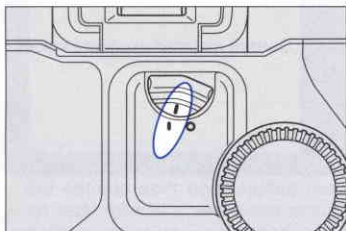

● Using the Quick Control Dial

- 1 Set the quick control dial switch to **I**.
- 2 Focus the subject and confirm the exposure.

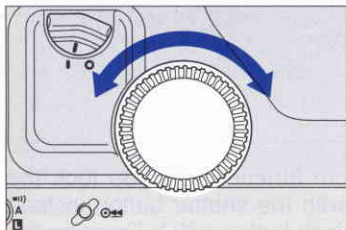

- 3 Turn the quick control dial to set the desired exposure compensation amount.
- The quick control dial is active only when the shutter button is half pressed or while the six-second timer is operating.

Exposure Compensation

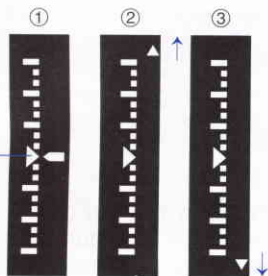

Correct exposure indicator

- ① Indicates correct exposure
- ② Indicates more than 3 stops overexposure
- ③ Indicates more than 3 stops underexposure

- The exposure level indicator and exposure compensation symbol are displayed in the viewfinder, and the compensation amount is displayed in the LCD panel's exposure level indicator.
- In the LCD panel, "+" indicates overexposure and "-" indicates underexposure relative to the camera's meter reading.
- In the viewfinder display, overexposure and underexposure are indicated respectively by exposure compensation amounts above and below the triangle index at the center of the scale.
- After setting the desired compensation amount, it is recommended to set the quick control dial switch to to prevent accidental alteration of the setting.
- To cancel the exposure compensation, operate the quick control dial to return the exposure level indicator to the zero () position.

4 Take the picture.

- The set exposure compensation amount is not canceled even if the main switch is set to .



If CF No. 6 is used to set the exposure compensation amount in 1/2-stop or 1/3-stop increments, the exposure level indicator in the viewfinder display and in the LCD panel appear as shown below.

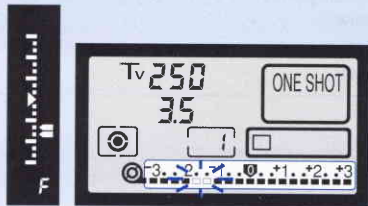

1-1/2 stops under

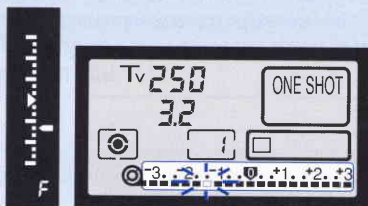

1-1/3 stops under

Exposure Compensation

● Using the Exposure Compensation Button

Exposure compensation can also be carried out using the exposure compensation button (\pm) together with the main dial.

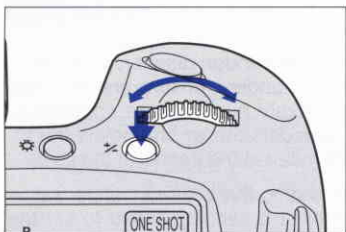



1 Focus the subject and confirm the exposure.

2 Press and release the exposure compensation button, then turn the main dial (while the six-second timer is activated) to set the desired exposure compensation amount.

3 Take the picture.

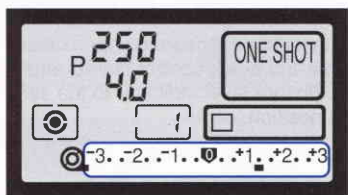
- The set exposure compensation amount is not canceled even if the main switch is set to " ".



- It is recommended to set the quick control dial switch to  to prevent accidental operation.
- The optionally available Command Back E1 does not have a quick control dial. When using this command back, set the exposure compensation by turning the main dial while pressing the exposure compensation button.

8. Auto Exposure Bracketing [AEB]

Use auto exposure bracketing to take a sequence of pictures at different exposures. When this function is set, the camera automatically takes three exposures in sequence while shifting the exposure for each picture. The bracketing amount can be set in 1/3-stop increments up to ± 3 stops from the metered exposure value. When the shutter button is pressed, three frames are exposed according to the current film winding mode (refer to “2. Changing the Film Winding Mode” on page 67), in the sequence: underexposure \rightarrow correct (metered) exposure \rightarrow overexposure.

Auto exposure bracketing is particularly effective when using slide film, which produces noticeably different results with even small exposure variations.



Underexposure ($-1/3$)

Correct (metered) exposure (0)

Overexposure ($+1/3$)

Custom Function F-5

(Refer to pages 86–87)

The AEB step amount can also be input in 1/2-stop increments.

Custom Function F-9

(Refer to pages 88–89)

The shooting sequence can be changed to: correct (metered) exposure \rightarrow underexposure \rightarrow overexposure. This function also lets you set the AEB step amount by simultaneously pressing the AF mode and shooting mode selectors while turning the main dial.



If auto exposure bracketing is used with custom function F-12 set to mirror-up mode, the camera will operate in single exposure mode regardless of the current film winding mode (single exposure, continuous exposure).

Auto Exposure Bracketing [AEB]

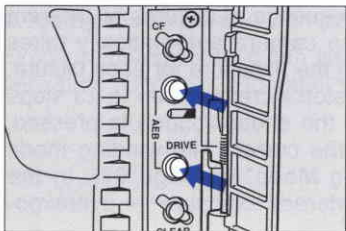

- 1 Open the palm door and simultaneously press the battery check button and film winding mode selector.

- AEB appears in the LCD panel.

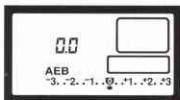

- The display remains for six seconds after you release the buttons.

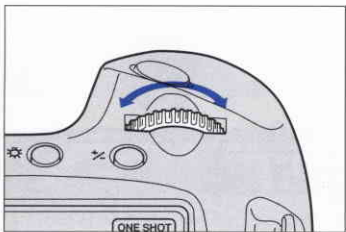

- 2 Turn the main dial to set the desired bracketing amount.

- The set bracketing amount is shown in the LCD panel as both a graphic level display and a numerical value. The diagram shows the case when setting a bracketing amount of $\pm 1\text{-}1/3$ stops.

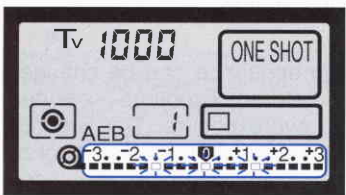
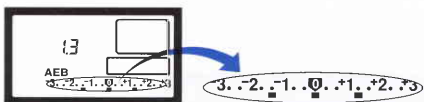

- Display when a bracketing amount of $\pm 1\text{-}1/3$ stops is set.

- 3 When you press the shutter halfway and then remove your finger, the bracketing amount is displayed by the viewfinder's exposure level indicator.

- 4 Take pictures according to the current film winding mode.

- The compensated exposure value for each shot is displayed in the LCD panel as the three frames are exposed, and the AEB indicator (*) blinks continuously until all three exposures are completed.

Auto Exposure Bracketing [AEB]

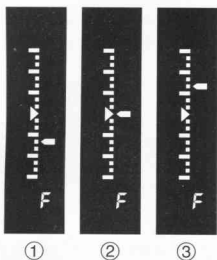

- Display examples of AEB exposures in the viewfinder

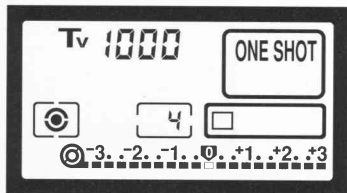

Custom Function F-9

(Refer to pages 88–89)

The camera can be set so that auto exposure bracketing is not canceled when the lens is exchanged, the film is loaded or rewound, or the main switch is set to “**L**”.



- By setting exposure compensation (see “7. Exposure Compensation” on page 42) after setting the auto exposure bracketing step amount, you can take three sequential overexposed or underexposed shots while varying the compensation for each shot. The bracketing step amount is not changed even when shifting the standard (metered) exposure.
- Auto exposure bracketing cannot be used in bulb mode or when using flash.
- Auto exposure bracketing cannot be set on the EOS-1 N RS in RS mode.

- The compensation amount for each shot is also displayed in the viewfinder by the exposure level indicator.
- It is possible to take one shot at a time even in continuous exposure mode. The AEB indicator (✱) blinks continuously until all three exposures are completed.
- If the shutter is held completely pressed in continuous exposure mode, three frames are exposed in sequence but the viewfinder's metering level indicator is not active. Film winding automatically stops after three frames.
- When AEB is used in conjunction with the self-timer, three frames are automatically exposed in sequence after a 2- or 10-second delay.

5 To cancel auto exposure bracketing, repeat steps 1 and 2 to reset the bracketing amount to 0.

- Auto exposure bracketing is also canceled when the lens is exchanged, the film is replaced or rewound, bulb exposure mode is set, flash charge completion is loaded, the clear button is pressed, or the main switch is set to “**L**”.

III Selecting the Shooting Mode

This section describes the camera's various shooting modes and provides guidelines on how to select the appropriate mode for different subjects.

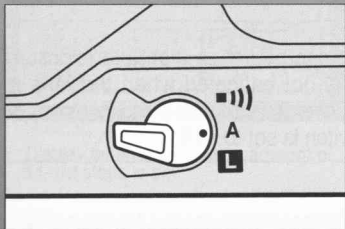
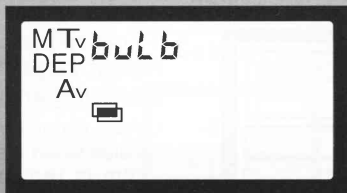

- First make sure the camera's main switch is set to "A" or "  "

1. Shutter-priority AE [Tv]

In this mode, you set the shutter speed and the camera automatically sets the aperture according to the lighting conditions.

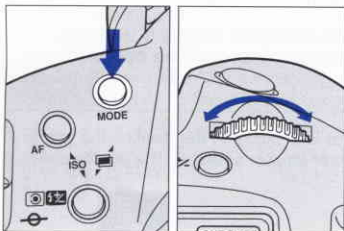

- 1 While pressing the shooting mode selector, turn the main dial until "Tv" appears in the LCD panel.

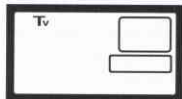

- 2 Release the shooting mode selector.

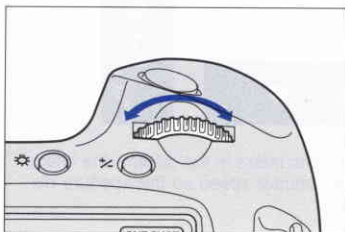

- 3 Turn the main dial until the desired shutter speed appears in the viewfinder or LCD panel.

- 4 Press the shutter button halfway to focus the subject and confirm the exposure.

- The shutter speed and corresponding aperture value are displayed in the viewfinder and LCD panel.

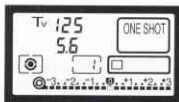

5 After confirming the aperture value, press the shutter button completely to take the picture.

- If the aperture value is not blinking, proper exposure will be obtained.

[Exposure Warnings]

- When the number for the maximum aperture of the lens blinks in the display, the image will be underexposed. Turn the main dial to a slower shutter speed so the aperture display stops blinking.

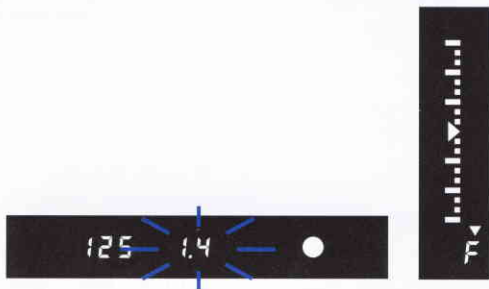

- When the number for the minimum aperture of the lens blinks in the display, the image will be overexposed. Turn the main dial to a faster shutter speed so the aperture display stops blinking.

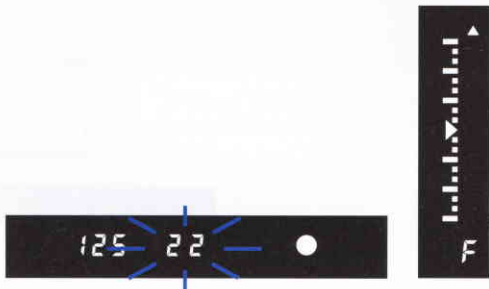



Shutter Speed Display

Shutter speeds are set in 1/3-stop increments. From 8000 to 4, the shutter speeds are displayed as the reciprocal of the actual time values. For example, 125 on the display indicates a shutter speed of 1/125 sec. For shutter speeds slower than 4, actual times are displayed. For example, 0"3 on the display indicates a shutter speed of 0.3 sec, and 15" indicates a speed of 15 sec. The following shutter speeds are available:

8000 6400 5000 4000 3200 2500 2000 1600 1250 1000 800 640 500 400
 320 250 200 160 125 100 80 60 50 40 30 25 20 15 13 10 8 6 5 4
 0"3 0"4 0"5 0"6 0"8 1" 1"3 1"6 2" 2"5 3"2 4" 5" 6" 8" 10" 13" 15" 20"
 25" 30"

Custom Function F-6

(Refer to pages 86–87)

In addition to 1/3-stop increments, shutter speeds can also be input in 1-stop or 1/2-stop increments. In these cases, available shutter speeds are as follows:

- **1-stop increments**

8000 4000 2000 1000 500 250 125
 60 30 15 8 4 0"5 1" 2" 4" 8" 15"
 30"

- **1/2-stop increments**

8000 6000 4000 3000 2000 1500
 1000 750 500 350 250 200 180
 125 90 60 45 30 20 15 10 8 6 4
 0"3 0"5 0"7 1" 1"5 2" 3" 4" 6" 8"
 10" 15" 20" 30"



Using a fast shutter speed
(1/1000 sec. at f/5.6)



Using a slow shutter speed
(1/60 sec. at f/22)

* Using an EF200mm f/2.8L USM lens

2. Aperture-priority AE [Av]

In this mode, you set the aperture and the camera automatically sets the shutter speed according to the lighting conditions.

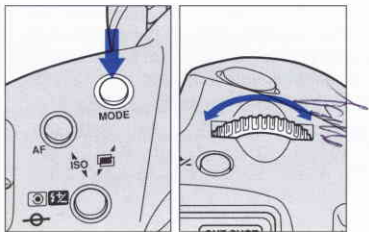

- 1 While pressing the shooting mode selector, turn the main dial until "Av" appears in the LCD panel.

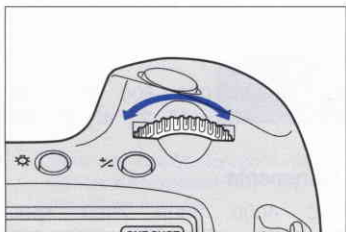
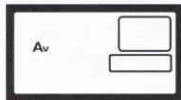

- 2 Release the shooting mode selector.
- 3 Turn the main dial until the desired aperture value appears in the viewfinder or LCD panel.
- 4 Press the shutter button halfway to focus the subject and confirm the exposure.
 - The aperture value and corresponding shutter speed are displayed in the viewfinder and LCD panel.

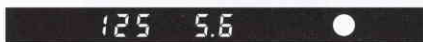
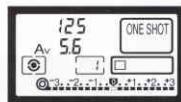

5 After confirming the shutter speed, press the shutter button completely to take the picture.

- If the shutter speed is not blinking, proper exposure will be obtained.
- Caution: Camera shake may produce an unsharp picture if the shutter speed becomes slower than "1/focal length of the lens in use."

[Exposure Warnings]

- When a shutter speed of 30" blinks in the display, the image will be underexposed. Turn the main dial to set a larger aperture (smaller aperture number) so the shutter speed stops blinking.



- When a shutter speed of 8000 blinks in the display, the image will be overexposed. Turn the main dial to set a smaller aperture (larger aperture number) so the shutter speed stops blinking.



Aperture-priority AE [Av]



Aperture Value Display

Apertures are set in 1/3-stop increments. Larger numbers indicate smaller lens apertures. The following aperture settings are provided in the camera, but the actual aperture range available depends on the lens in use.

1.0 1.1 1.2 1.4 1.6 1.8 2.0 2.2 2.5 2.8 3.2 3.5 4.0 4.5 5.0 5.6 6.3 7.1
8.0 9.0 10 11 13 14 16 18 20 22 25 29 32 36 40 45 51 57 64 72
81 91

Custom Function F-5

(Refer to pages 86–87)

In addition to 1/3-stop increments, aperture values can also be input in 1-stop or 1/2-stop increments. In these cases, available aperture values are as follows:

- **1-stop increments**

1.0 1.4 2.0 2.8 4.0 5.6 8.0 11 16
22 32 45 64 91

- **1/2-stop increments**

1.0 1.2 1.4 1.8 2.0 2.5 2.8 3.5 4.0
4.5 5.6 6.7 8.0 9.5 11 13 16 19
22 27 32 38 45 54 64 76 91

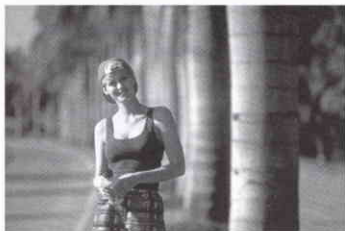

Using a large aperture
(1/1000 sec., f/2.0)

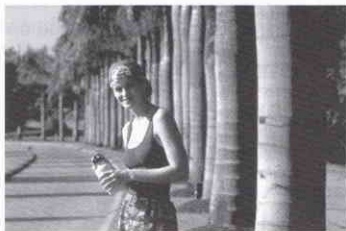

Using a small aperture
(1/60 sec., f/16)

* Using an EF50mm f/1.4 USM lens

3. Depth-of-Field AE [DEP]

This mode places everything between two freely set points in the foreground and background within the zone of focus, effective for making sure everyone in a large group picture or everything in a landscape photo is rendered sharp. After you designate the near and far points in the scene, the camera automatically sets the optimum focus position and the aperture necessary to achieve the required depth of field, then sets the shutter speed to achieve the correct exposure. The near and far points can be designated using the selected focusing point in manual focusing point selection mode, or using the center point in automatic focusing point selection mode.

- Depth-of-field AE is not possible when the lens' focus mode switch is set to "M". Make sure the focus mode switch is set to "AF".

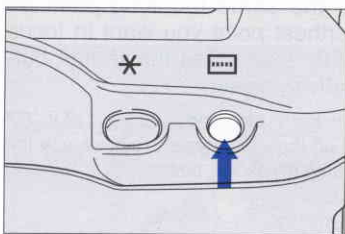

● Using Manual Focusing Point Selection Mode

- 1 Select the desired focusing point.

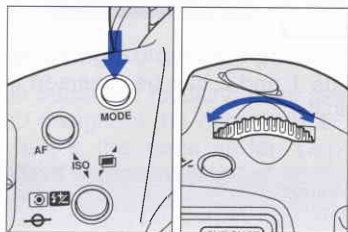

- 2 While pressing the shooting mode selector, turn the main dial until "DEP" appears in the LCD panel.

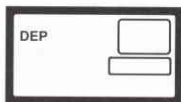

- 3 Release the shooting mode selector.

Depth-of-Field AE [DEP]



- 4 Place the selected focusing point on the nearest point you want in focus (point 1), then press the shutter button halfway.

- When the in-focus indicator and “dEP 1” light up in the viewfinder, remove your finger from the shutter button.

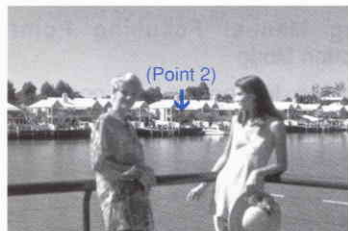
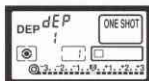

- 5 Place the same focusing point on the farthest point you want in focus (point 2), then press the shutter button halfway again.

- When the in-focus indicator and “dEP 2” light up in the viewfinder, remove your finger from the shutter button.



- Points 1 and 2 can be reversed if desired.



Depth-of-Field AE [Dep] is not available on the EOS-1 N RS.

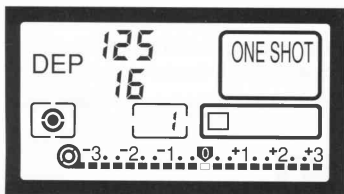

6 Compose the picture and press the shutter button halfway to set the aperture and focus for the designated depth of field.

- The correct aperture value for the designated depth of field and the corresponding shutter speed are displayed in both the viewfinder and LCD panel.
- If you remove your finger from the shutter button, the display changes to "dEP" and the aperture value.
- The exposure is determined immediately before the shutter is released.

7 Press the shutter button completely to take the picture.

● Using Automatic Focusing Point Selection Mode

In automatic focusing point selection mode, use the center focusing point to designate the near and far focus points. Otherwise, the basic procedure is the same as for "Depth-of-Field AE Using A Manual Focusing Point Selection Mode".

Depth-of-Field AE [DEP]

[Warning Indications]

- If the aperture value blinks, the desired depth of field cannot be obtained. Use a wide-angle lens or move farther from the subject and repeat steps 4 through 6.
- If the shutter speed of 30" and the maximum aperture of the lens blink, the scene will be underexposed and Depth-of-Field AE cannot be carried out.



- If the shutter speed of 8000 and the minimum aperture of the lens blink, the scene will be overexposed. Use a neutral density (ND) filter to reduce the amount of light entering the lens.



- When using a zoom lens, do not zoom the lens until you finish taking the picture.
- Changing the focusing point during Depth-of-Field AE operation cancels any previously set data.
- Flash cannot be used effectively in depth-of-field AE mode. Use of flash will provide the same result as using flash in Program AE mode.
- When using a lens equipped with a focus range selector (such as the EF300mm f/2.8L USM), be sure to set it to the maximum range.



- If the camera sets a slow shutter speed, use a tripod to prevent camera shake.
- To cancel Depth-of-Field AE in mid-operation, press the focusing point selector, the shooting mode selector, the AF mode selector or the metering mode selector.



- For greater depth of field, we recommend using a wide-angle lens.
- For shallow depth of field, place both points 1 and 2 on the same point. This method is effective for blurring the foreground and background when shooting portraits. Use a telephoto lens for best effect.

4. Manual Exposure [M]

This mode lets you set both the shutter speed and aperture. Use this mode when you need complete control of exposure for creative effects or when using a hand-held exposure meter.

The main dial sets the shutter speed and the quick control dial sets the aperture.

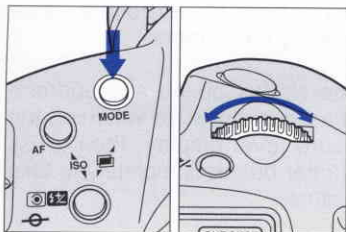

● Using the Camera's Built-in Meter

- 1 While pressing the shooting mode selector, turn the main dial to the left or right until "M" appears in the LCD panel.

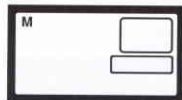

- 2 Release the shooting mode selector.
- 3 Set the quick control dial switch to I.
- 4 Turn the main dial to the desired shutter speed and the quick control dial to the desired aperture.

- The optionally available Command Back E1 is not equipped with a quick control dial. When using the Command Back E1, set the aperture by pressing the exposure compensation button and turning the main dial.

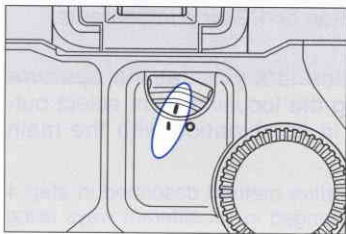



- The ◻ indicator shows that the set exposure will be one stop over the metered exposure.

5 Press the shutter button halfway to focus the subject. “M” and the exposure values are displayed in the viewfinder. The exposure level indicator at the right of the viewfinder shows how far the current exposure setting is from the exposure value metered by the camera.

6 Set the shutter speed and aperture value as desired while watching the exposure level display, then press the shutter button completely to take the picture.

Custom Function F-5

(Refer to pages 86–87)

This custom function lets you switch the functions of the main dial and quick control dial.

Custom Function F-6

(Refer to pages 86–87)

In addition to 1/3-stop increments, shutter speeds and aperture values can also be input in 1-stop or 1/2-stop increments.

Custom Function F-11

(Refer to pages 90–91)

This function lets you set the aperture value using the focusing point select button () in combination with the main dial.

- The operation method described in step 4 can be changed in six different ways using various combinations of custom functions 5 and 11 (refer to page 92).

5. Bulb Exposure [bulb]

The shutter stays open for as long as you press the shutter button. By connecting the optional Remote Switch 60T3 to the camera's remote control socket, you can keep the shutter open without holding the shutter button pressed. Use this mode when long exposures are required, such as for pictures of night scenes and fireworks displays.

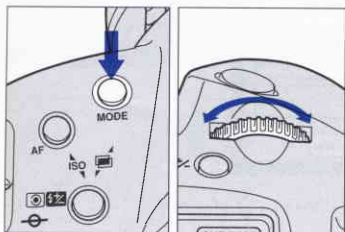

- 1 While pressing the shooting mode selector, turn the main dial until "bulb" appears in the LCD panel.

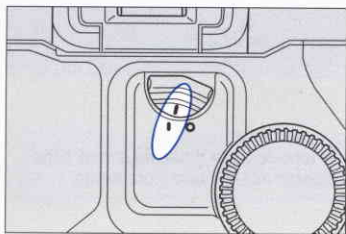
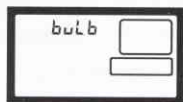

- 2 Release the shooting mode selector.
- 3 Set the quick control dial switch to I.

- 4 While looking at the LCD panel, turn the main dial or quick control dial until the desired aperture value appears in the display.

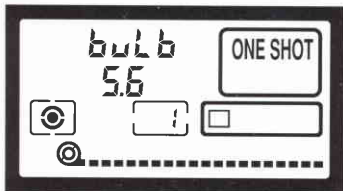

- 5 Press the shutter button completely and hold it pressed for the desired length of time.

Bulb Exposure [bulb]



- In bulb exposure mode, the LCD panel's frame counter display counts the elapsed time from when the shutter was released, starting over every 30 seconds. One battery check bar (■■■■) appears on the display after every 30 seconds, allowing time measurement up to 120 seconds using all three bars.

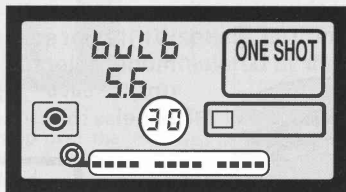

This display example shows elapsed time of 120 seconds

- This camera's bulb exposure operation is designed to consume very little power, realizing virtually no drain on the battery.
- LCD panel illumination is turned off during bulb exposure operation.



- Optional accessory Command Back E1 features a long-release timer for timed exposures up to 23 hours, 59 minutes, 59 seconds, adjustable in 1-second increments.

6. Multiple Exposures []



Up to nine exposures can be made on one frame by presetting the number of multiple exposures with the main dial. Multiple exposures are possible in any shooting mode.

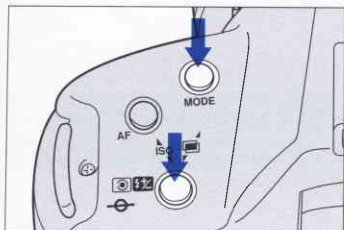

- 1 Press the shooting mode selector and metering mode selector/flash exposure compensation button at the same time.

- “” appears in the LCD panel and “!” appears in the frame counter. This number indicates the number of preset multiple exposures.

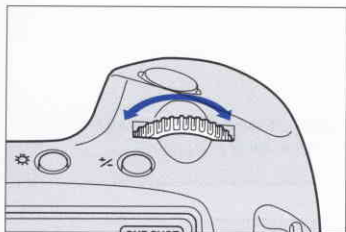
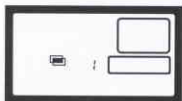

- 2 Turn the main dial to set the desired number of preset multiple exposures.

- To cancel, turn to the left.

Multiple Exposures []

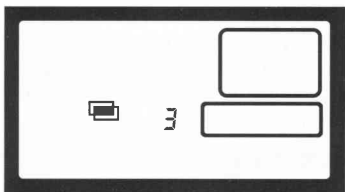

- Three exposures are set

- 3 Release the shooting mode selector and metering mode selector/flash exposure compensation button.
- 4 Select a shooting mode and take the desired number of exposures.
- 5 When the preset number of multiple exposures is completed, the film automatically advances to the next frame.



When taking multiple exposures on the first or last frame of a roll, the curl of the film may cause subject images to shift slightly out of alignment.



- “” blinks in the LCD panel during multiple exposure photography.
- To cancel multiple exposure mode before starting to take pictures, reset the number of multiple exposures in the display to “1”.
- To cancel multiple exposure mode in mid-operation, repeat steps 2 and 3 to set the frame counter to a blank display.



When taking multiple exposures on a single frame, you should decrease the exposure value for each exposure using exposure compensation. See “7. Exposure Compensation” on page 42.

Approximate exposure compensation

Number of multiple exposures	2 exposures	3 exposures	4 exposures
Compensation amount per exposure	-1.0	-1.5	-2.0

- The above values should be used only as a guide. The actual compensation amount required depends on the shooting conditions and should be determined by prior testing.

IV Configuring the Camera

This section describes how to change various camera settings such as the film speed and film winding and rewinding modes, allowing you to precisely configure the camera for specific shooting situations.

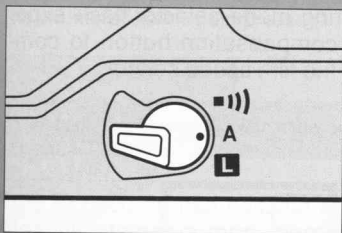

- First make sure the camera's main switch is set to "A" or "■||)" "

1. Manually Setting the Film Speed

The film speed can be set manually when using non-DX film or when you wish to set a film speed other than the DX-coded film speed.

- Set the film speed after loading the film.
- The manual film speed setting range is ISO 6~6400. When using DX film, the automatic film speed setting range is ISO 25~5000.

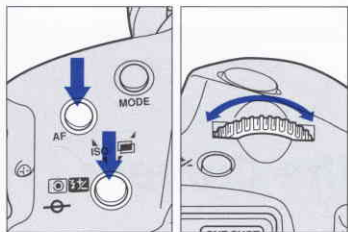

1 While simultaneously pressing the AF mode selector and metering mode selector/flash exposure compensation button, turn the main dial to the left or right until the desired film speed is displayed in the LCD panel.

- When the AF mode selector and metering mode selector are pressed simultaneously, "ISO" and the currently set film speed are displayed in the LCD panel.



2 Release the AF mode selector and metering mode selector/flash exposure compensation button to complete the film speed setting.



The manually-set film speed is automatically canceled when new DX-coded film is loaded.

Custom Function F-3

(Refer to pages 84–85)

This custom function can be used to prevent the camera from automatically setting the film speed according to the film's DX code. When this function is set, the camera does not change the manually set film speed when changing film, handy when using many rolls of the same type of film in succession.

2. Changing the Film Winding Mode

Two film winding modes are available: single exposure mode and continuous exposure mode.

● Single Exposure (□)

The film advances one frame after each picture is taken. After taking a picture, return the shutter button to the half-pressed position to prepare for the next exposure while keeping the exposure value locked (possible only when camera is set to One-shot AF and evaluative metering mode).

● Continuous Exposure (□)

Pictures are taken continuously at a rate of approx. 3 frames per second as long as the shutter button is held pressed.

◆ Attaching the optional Power Drive Booster E1 provides the following two continuous exposure modes:

● Continuous Exposure (□ L)

Pictures are taken continuously at a rate of approx. 3 frames per second as long as the shutter button is held pressed.

● High-Speed Continuous Exposure (□ H)

Pictures are taken continuously at a rate of approx. 6 frames per second as long as the shutter button is held pressed.

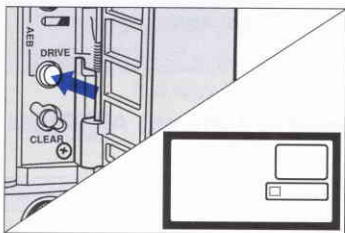

1 Open the palm door and press the film winding mode selector.

- The current film winding mode is displayed in the LCD selector.
- The timer keeps the film winding mode displayed for approx. 6 seconds after you release the selector.



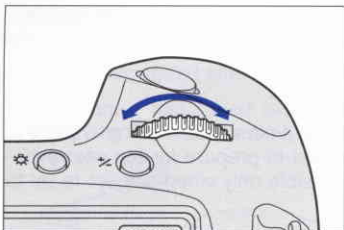

Changing the Film Winding Mode



- 2 Turn the main dial to the left or right until the desired film winding mode is displayed in the LCD panel.
- 3 To complete the setting, press the shutter halfway or wait until the six-second timer elapses.



Film Winding Automatic Gear Switching Function

If film winding becomes an excessive burden to the camera due to a sharp drop in battery capacity (which can occur when shooting in a cold environment), the film winding system automatically switches gears to reduce the winding speed and minimize battery drain. When this occurs, one of the film winding mode indicators ( •  •  • ) blinks in the LCD panel.

To cancel this function and return to normal-speed winding, open the palm door and press the film winding mode selector. This function is also canceled automatically when the film is exchanged or the battery is replaced. When the camera automatically switches to reduced-speed winding, check the battery level (see page 15) and replace the battery or prepare a new battery as indicated.

- When film winding or rewinding stops in mid-operation, the “ bε ” indicator blinks in the LCD panel. When the battery is replaced with a new one, film winding continues automatically. If the camera stopped in the middle of rewinding, press the film rewind button () to continue the rewinding operation.
- Do not dispose of the battery if its capacity drops due to cold shooting conditions. Its capacity may return when it returns to normal temperature.

● Maximum Continuous Shooting Speed in Different AF Modes (frames/sec.)

	One-shot/Manual	AI Servo
Continuous exposure ()	approx. 3 fps	approx. 2 fps

- Refer to page 97 for the maximum shooting speeds in different AF modes with Power Drive Booster E1.



3. Changing the Film Rewinding Mode

In normal operation at the end of the roll, the camera automatically rewinds the film at high speed and winds the film leader completely into the cartridge. Using custom functions F-1 and F-2, however, you can change the camera's film rewinding operation as described below:

- Custom Function Nos. F-1 and F-2 can be used in combination.
 - For instructions on how to change the custom function settings, see "1. Setting and Resetting Custom Functions" on page 82.
-

Custom Function F-1 Settings

(Refer to pages 84–85)

- F-1-0** High-speed rewinding starts automatically at the end of the roll.
 - F-1-1** Rewinding does not start automatically at the end of the roll and starts when the film rewind button () is pressed.
 - F-1-2** Silent rewinding starts automatically at the end of the roll.
 - F-1-3** Rewinding does not start automatically at the end of the roll. Silent rewinding starts when the film rewind button () is pressed.
-

Custom Function F-2 Settings

(Refer to pages 84–85)

- F-2-0** At the end of rewinding, the camera winds the film leader all the way into the cartridge.
 - F-2-1** At the end of rewinding, the camera leaves the film leader outside the cartridge.
-

4. Using the Self-Timer []

Two built-in self-timer modes let you delay the exposure 10 seconds or 2 seconds from when you press the shutter button. When using the self-timer, place the camera on a tripod or a steady surface.

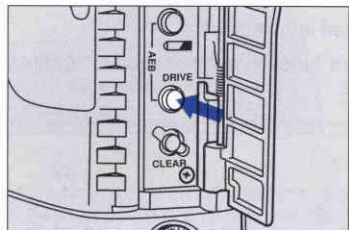

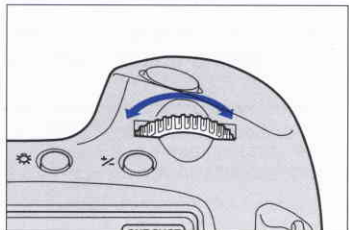
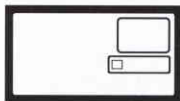

1 Open the palm door and press the film winding mode selector.

- The film winding mode indicator appears in the LCD panel.
- After the button is released, the timer function keeps the film winding mode indicator displayed in the LCD panel for six seconds.



2 Turn the main dial to the left or right until the desired self-timer mode appears in the LCD panel.

-  : 10-second timer
-  : 2-second timer



Use the 10-second self-timer when taking a picture of a group of people or a scene that you want to be a part of, and use the 2-second self-timer when you want to minimize camera-shake (camera vibration induced when the shutter button is pressed) while taking close-up pictures or duplicate photos.

3 Looking into the viewfinder, compose the picture and press the shutter button halfway to focus the subject and set the exposure.

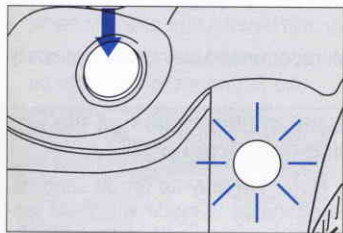

4 Press the shutter button completely. The self-timer lamp blinks to indicate that the self-timer function is operating. The lamp starts blinking faster two seconds before the picture is taken.

- To cancel the self-timer in mid-operation, set the main switch to .



- Be careful not to stand in front of the lens when pressing the shutter button, as this will cause the camera to misfocus.

● Using the Eyepiece Shutter

To prevent metering errors caused by light entering the eyepiece when pressing the shutter button with your eye away from the viewfinder, close the eyepiece shutter before pressing the shutter button. Recommended when using the self-timer or making long time exposures.

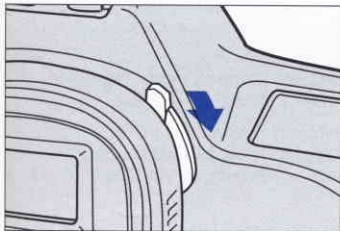

Push down the eyepiece shutter lever in the direction of the arrow to close the eyepiece shutter. Lift the lever in the opposite direction to open.

5. Locking the Mirror Up

Setting custom function F-12 (refer to pages 90-91) lets you swing the mirror up before opening the shutter and starting the exposure. This eliminates the slight vibration caused by mirror shock, ensuring maximum sharpness when taking close-up photos or using super-telephoto lenses.

- Refer to “1. Setting and Resetting Custom Functions” on page 82 for instructions on how to set the custom function.
- For best results with mirror-up shooting, we recommend using the optionally available Remote Switch 60T3.

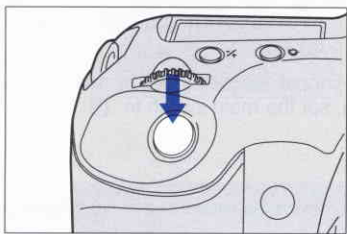

1 Press the shutter button all the way to swing the mirror up.

- The mirror will stay up for 30 seconds. If no operation is made within 30 seconds, the mirror will automatically return to its normal position without taking a picture. Pressing the shutter button again will return the mirror to the raised position.

2 Momentarily let up on the shutter button, then press it again completely to take the picture. The mirror returns to its normal position after the exposure is completed.



- When shooting outdoors on a bright day or in a bright location such as a ski slope or a sea shore on a fine day, take the picture within 30 seconds after swinging the mirror up to avoid burning the shutter curtain.
- Do not point the camera lens at direct sunlight when the mirror is in the up position to avoid burning the shutter curtain.
- When the mirror-up function is set, the film is wound one frame at a time, regardless of the film winding mode (single exposure or continuous exposure).
- If the self-timer is used in combination with the mirror-up function, the mirror swings up when the shutter button is first pressed, then the shutter releases automatically after a delay of 10 seconds (in 10-second self-timer mode) or 2 seconds (in 2-second self-timer mode).
- The timer function of the optionally available Command Back E1 cannot be used in mirror-up mode.
- When using the bulb exposure and self-timer modes in combination with the mirror-up function, a shutter release-type sound is heard when you remove your finger from the shutter button while the self-timer is operating, but no picture is actually taken.

6. Infrared Photography

Infrared film (film with extended sensitivity to infrared light) can be used to achieve interesting effects not possible with general-purpose film. When using black-and-white infrared film, the film's sensitivity to longer wavelengths requires a slight adjustment in focus using the red infrared index on the lens. Use a deep red filter to maximize the infrared effect.

- When shooting with infrared film, use a lens equipped with a distance scale window.
- For black-and-white and color infrared photography, read the instructions provided with the film for proper use.

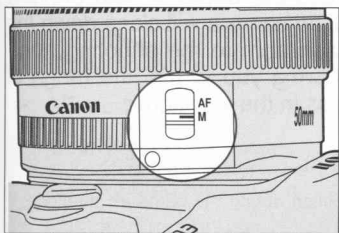

- 1 Focus the subject.
- 2 Set the lens' focus mode switch to "M".
- 3 Read the focus distance from the distance scale window.

- In this example, the distance from the camera to the subject is 3 m / 10 ft.

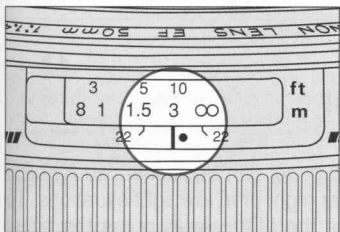

- 4 Manually align the lens' infrared index with the 3 m / 10 ft index on the distance scale.

- The lens' infrared index is set for a wavelength of 800 nanometers. However, the wavelength characteristics of general black-and-white infrared film varies depending on the type (750~830 nanometers). Therefore, to ensure proper focus when shooting with infrared film, we recommend to take extra shots with the lens adjusted slightly to the front and rear of the infrared index.

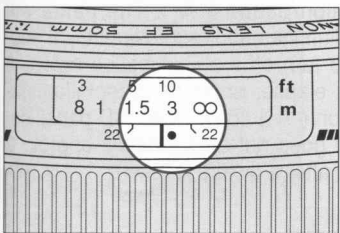

- The characteristics of the lenses listed below are such that they do not require focus adjustment when using black-and-white infrared film. These lenses are therefore not equipped with an infrared index.
EF200mm f/1.8L USM
EF300mm f/2.8L USM
EF500mm f/4.5L USM
EF600mm f/4L USM

7. Checking the Depth of Field

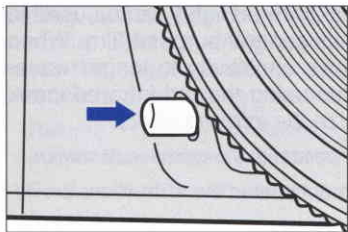

Depth of field is the range of focus in front of and behind the subject in which objects appear sharp. The depth of field varies from shallow to deep depending on the aperture setting, the angle of view of the lens in use and the camera to subject distance. To check the depth of field before taking a picture, press the depth-of-field preview button. The camera will close down the lens' diaphragm to the shooting aperture, allowing you to see the range of sharpness in the viewfinder.



- Exposure setting is locked when the depth-of-field preview button is pressed.
- The depth-of-field preview button does not function during the camera's autofocus operation.

8. Illuminating the LCD Panel

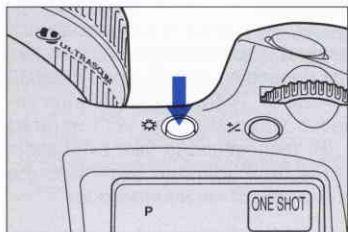

The LCD panel can be illuminated for easy viewing at night or in low light situations. To illuminate the LCD panel, press the panel illumination button (☀). The panel will remain illuminated for approximately 6 seconds. To turn off the illumination before 6 seconds elapse, press the panel illumination button (☀) again. The LCD panel illumination goes out automatically approx. 2 seconds after a picture is taken.



- You can keep the LCD panel illuminated longer than 6 seconds by pressing any operation button again while the illumination timer is activated.
- The LCD panel cannot be illuminated during bulb exposures.

9. Resetting the Camera to Its Initial Settings

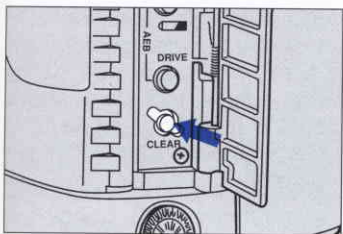

● Resetting All Camera Functions

You can reset all of the camera's functions (except for the custom functions) to their default settings by opening the palm door and pressing the clear button. After resetting, the camera's functions are set as shown below:

- | | |
|---------------------------|-----------------------|
| • Shooting mode | Program AE (P) mode |
| • AF mode | One-shot AF |
| • Metering mode | Evaluative metering |
| • Film winding mode | Single exposure (□) |
| • Custom functions | Not affected |



When custom function F-8 is set for center-weighted average metering instead of evaluative metering, and the metering mode is set to partial metering or spot metering, pressing the clear button will reset all of the camera functions except for the metering mode, which remains at the current setting.

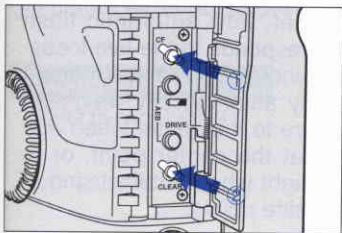

● Resetting All Custom Functions

You can reset all of the custom functions to their initial settings by pressing the custom function button before pressing the clear button.

V Using Flash

Attaching an EOS dedicated speedlite to the camera's accessory shoe enables advanced flash photography with the operational simplicity of normal AE shooting. In addition to overall exposure compensation, independent compensation of just the flash exposure is possible from the camera side.

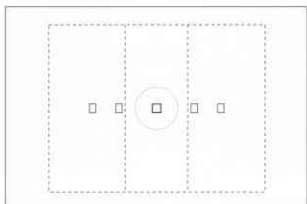

Operation of the built-in three-zone (center, right, left) automatic flash sensor corresponds to the five focusing points, increasing flash exposure precision by automatically weighting the exposure to the center when autofocusing at the center point, or to the left or right when autofocusing at one of the side points.

1. Using EOS Dedicated Speedlites

EOS dedicated Speedlites (540EZ, 430EZ, 420EZ, 300EZ, etc.) make flash photography as simple as pointing and shooting. Moreover, built-in advanced functions make it easy to achieve professional fill-in flash effects in outdoor settings as well as automatic control of flash exposure when shooting at night or indoors. These units feature a built-in AF auxiliary light function that assists autofocus in dark situations.

By simply attaching an EOS Speedlite to the camera and turning it on, an appropriate flash synchronization speed (1/250 sec. or slower) is automatically set on the camera. As soon as the flash is charged, the flash charge completion indicator appears in the viewfinder. For details, refer to your speedlite's instruction book.



- The 540EZ's AF auxiliary light is designed to work with all five of the EOS-1 N's focus points. Other EZ Speedlites' AF auxiliary light works with only the center focusing point.
- The 480EG does not emit an AF auxiliary light.
- The aperture values displayed on the camera and speedlite LCD panels may sometimes differ. However, the exposure will be correct.
- When using flash in AI Servo AF mode, the flash unit's AF auxiliary light will not function. In situations requiring use of the AF auxiliary light, switch to One-shot AF mode.

● Automatic Flash Output Reduction Control

When using a dedicated speedlite to take a photo of a subject lit by sky-light-type illumination, the camera automatically reduces the flash unit's light output so as not to overexpose the subject.

Custom Function *F 14*

(Refer to pages 90–91)

You can turn off the automatic flash output reduction control function for strongly-backlit subjects which need extra illumination from the flash.

2. Flash Exposure Compensation

This function lets you vary the automatic flash exposure level of EOS dedicated speedlites. The flash exposure can be compensated up to ± 3 stops in 1/3-stop increments.

Custom Function F-6

(Refer to pages 86–87)

Flash exposure compensation can also be set in 1/2-stop increments.

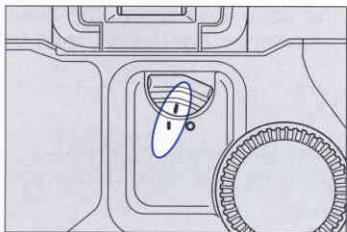

- 1 Set the quick control dial switch to I.

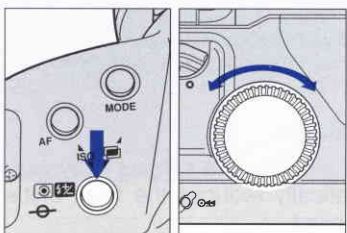

- 2 While pressing the metering mode selector / flash exposure compensation button, turn the quick control dial to set the desired compensation amount.

- The flash exposure compensation amount is displayed in the LCD panel's exposure compensation display.
- In the LCD display, the "+" side indicates overexposure compensation, and the "-" side indicates underexposure compensation.

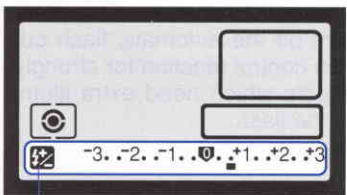

Flash exposure compensation

- Example showing +2/3-stop flash exposure compensation.

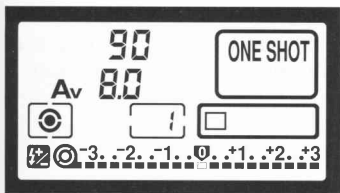

3 Releasing the metering mode selector / flash exposure compensation button completes the flash exposure compensation setting. The LCD panel returns to its normal condition and  lights in the display to indicate that flash exposure compensation is set. (The compensation amount is not displayed.)

- Flash exposure compensation remains set until manually canceled. To cancel, repeat step 2 to return the flash exposure compensation amount to 0.
- The exposure compensation amount remains set even if the main switch is set to “”.



The optionally available Command Back E1 does not have a quick control dial. When using this command back, set the flash exposure compensation by turning the main dial while simultaneously pressing the metering mode selector / flash exposure compensation button and focusing point selector.

● Speedlites Capable of Flash Exposure Compensation

This camera can perform flash exposure compensation with all Canon EOS dedicated Speedlites. The 540EZ and 430EZ Speedlites are also equipped with a built-in flash exposure compensation function. When this camera is used with the 540EZ or 430EZ and flash exposure compensation is set on both the camera and flash unit, the settings on the flash unit have priority and override the camera setting.

- Flash exposure compensation with EOS dedicated Speedlites is supported with the Canon Off-camera Shoe Cords and Canon multiple flash accessories connected to the camera by TTL Hot Shoe Adapters 2 and 3.



When using the 300TL Speedlite, set the flash mode button to a position other than MHi or MLo. TTL automatic flash exposure is possible.



Canon Speedlites other than those mentioned above can be used in manual mode.

3. Using Non-dedicated Flash Equipment

This camera's shutter can synchronize with non-dedicated portable flash units at up to 1/250 sec. and with studio strobes at up to 1/125 sec. Before use, test the flash unit at various shutter speeds to make sure it synchronizes properly with the camera.

● PC Terminal

Flash units equipped with a synchro cord can be used by connecting the cord to the camera's PC terminal. The PC terminal is equipped with a lock screw to prevent accidental disconnection.

The PC terminal provides only an X-sync contact and synchronizes at all shutter speeds up to 1/250 sec.

- TTL automatic flash control is not possible.



- Flash units can be connected to both the PC terminal and accessory shoe for multiple flash setups.



● We recommend using Canon dedicated speedlites with this camera.

- Use of flash units (having two or more contacts on the hot shoe) or flash accessories that are designed for dedicated use with other brands of cameras will not work properly and may result in damage to your EOS camera.
- Use of flash units of other brands with a trigger circuit voltage in excess of 6 volts DC may damage your camera. Consult your nearest authorized Canon service facility to confirm the compatibility.

VI Custom Functions

Custom function control is provided to let you customize the camera's functions according to your personal preferences and shooting style.

1. Setting and Resetting Custom Functions

● Setting a Custom Function

1 Set the main switch to “A” or “A technical diagram of the control panel. On the left, there is a vertical row of buttons. To the right, there is a circular main dial with a '+' sign at the top and a '-' sign at the bottom. A blue arrow points to the dial. Further right, there is a custom function button labeled 'CF' with a '+' sign above it. A blue arrow points to this button. Below the 'CF' button are labels for 'BBV' and 'DRIVE'. A palm door is shown partially open on the right side.

2 Open the palm door and press the custom function button.

- A custom function number is displayed in the LCD panel.

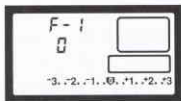

3 Turn the main dial to the left or right until the desired custom function number is displayed in the LCD panel.

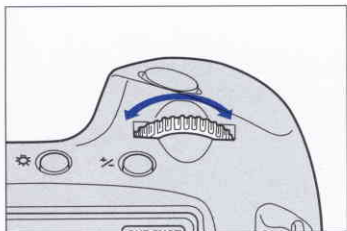

4 Press the custom function button until the number corresponding to the desired setting for the selected custom function appears in the LCD panel. The number changes each time the custom function button is pressed.

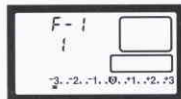
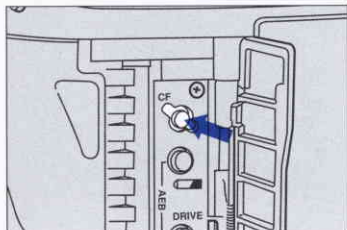

Setting and Resetting Custom Functions

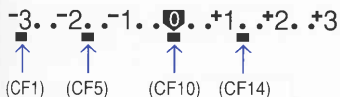

- Display example indicating that custom functions No. 1, No. 5, No. 10 and No. 14 are set.

- Dots are displayed below the exposure scale to indicate custom function settings which have been selected.

A dot below “-3” indicates that custom function No. 1 is set. Dots for other custom functions (Nos. 2~14) are displayed in sequence to the right of the “-3” position.

- You can check the custom function setting status at any time by pressing the custom function button to activate the status display.

- 5 Press the shutter button halfway to complete the setting and restore the LCD panel to the original display.

● Resetting a Custom Function

- 1 To reset a custom function to the standard setting, select the custom function and then press the custom function button to change the number in the LCD panel to “0”.

- 2 Press the shutter button halfway to complete the reset operation and restore the LCD panel to the original display.

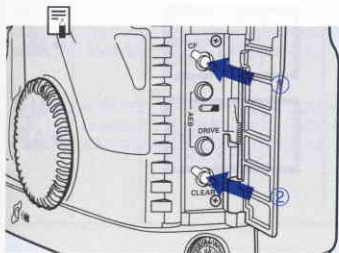
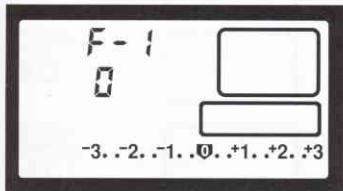
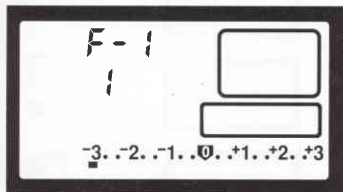







Resetting All Custom Functions At Once

You can reset all the custom functions at once to their default (0) settings by pressing the clear button after pressing the custom function button, while the camera is in the custom function setting mode.

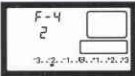

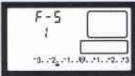

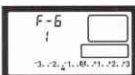
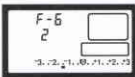

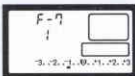



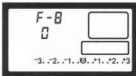



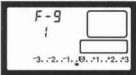

2. Custom Function Chart

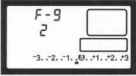
Type	Custom Function No.	Affected Function	LCD Panel Display	Setting No.	Sticker Symbol
Film handling	F-1	Automatic film rewind operation		0	
				1	
				2	
				3	
	F-2	Film leader retrieval after rewinding		0	
				1	
F-3	Film speed setting		0	ISO DX	
			1	ISO M	
Focus	F-4	AF operation method		0	<ul style="list-style-type: none"> ● AF ● AEL
				1	<ul style="list-style-type: none"> ● AEL ● AF

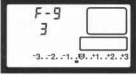



















Operation	Useful Situations	Reference Page No.
<p>High-speed automatic rewind.</p> <p>Automatic rewind prohibited.</p> <ul style="list-style-type: none"> • Pressing film rewind button activates high-speed rewind. <p>Silent automatic rewind. (Low speed)</p> <p>Automatic rewind prohibited.</p> <ul style="list-style-type: none"> • Pressing film rewind button activates silent rewind. (Low speed) 	<p>This function is useful for situations in which silence is required — for example, in a quiet theater or at a pro golf tournament — where the sudden noise of a camera's rewind would cause disruption and be frowned upon.</p>	69
<p>Rewinds film leader fully into the cartridge.</p> <p>Leaves the film leader outside the cartridge after rewinding.</p>	<p>This function is useful for individuals or news companies who do their own film processing. The film leader is left outside of the cartridge after the film is rewound automatically or in mid-roll.</p>	69
<p>Film speed set automatically according to DX code.</p> <p>Film speed set manually. (DX code is ignored.)</p>	<p>This option is for photographers who shoot film at ISO settings determined from their own tests. Setting this function frees the photographer from having to change the film speed every time a new roll is loaded.</p>	66
<p>Autofocus starts when shutter button is pressed halfway. Exposure is locked when AE lock button (*) is pressed.</p> <p>Autofocus starts when AE lock button (*) is pressed. Exposure is locked when shutter button is pressed halfway.</p>	<p>1: This option lets the photographer carry out metering and autofocusing independently.</p>	31 41

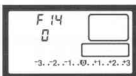

Type	Custom Function No.	Affected Function	LCD Panel Display	Setting No.	Sticker Symbol
Focus	F-4	AF activation		2	● AF ● AFL
Exposure	F-5	Shutter speed and aperture value setting method in manual exposure mode		0	☞ Tv ☼ Av
				1	☞ Av ☼ Tv
	F-6	EV steps for the shutter speed, aperture, exposure compensation, flash exposure compensation, and AEB	  	0 1 2	1/3 STEP 1 STEP 1/2 STEP
Focus	F-7	Manual focusing with the electronic manual focusing ring	 	0 1	AF M AF

Operation	Useful Situations	Reference Page No.										
<p>Autofocus starts when shutter button is pressed halfway. Focus is locked when AE lock button (*) is pressed.</p> <ul style="list-style-type: none"> • AE lock is not possible when "2" is set. 	<p>2: For sports photography using focus prediction in AI Servo AF mode, this option lets the photographer temporarily stop the focus.</p>											
<p>Shutter speed set by main dial. Aperture value set by quick control dial or by combined operation of exposure compensation button (±) and main dial.</p> <p>Aperture value set by main dial. Shutter speed set by quick control dial or by combined operation of exposure compensation button (±) and main dial.</p> <ul style="list-style-type: none"> • For operation when combined with custom function F-11, refer to "Combined Use of Custom Functions F-5 and F-11" on page 92. 	<p>When making manual exposure adjustments, this function lets the photographer choose whether to use the main dial for adjusting the shutter speed or aperture value. This option is convenient for studio flash photography where the shutter speed is kept constant while the aperture is frequently varied to alter depth of field and exposure.</p>	60										
<p>Shutter speed, aperture value and exposure compensation, flash exposure compensation and AEB step amounts set in 1/3-stop increments.</p> <p>Shutter speed and aperture value set in 1-stop increments, and exposure compensation, flash exposure compensation and AEB step amounts set in 1/3-stop increments.</p> <p>Shutter speed, aperture value and exposure compensation, flash exposure compensation and AEB step amounts set in 1/2-stop increments.</p>	<p>This function lets the photographer input shutter speed and aperture settings in any increment that he or she is used to. 1/2-stop exposure compensation settings are also possible, providing wide flexibility to satisfy various shooting styles.</p>	42 45 51 54 60 78										
<p>Manual focusing is possible.</p> <ul style="list-style-type: none"> • This function works only with lenses equipped with an electronic manual focusing ring. <p>Manual focusing is prohibited.</p> <ul style="list-style-type: none"> • Manual focusing by setting the lens' focus mode switch to "M" is possible. 	<p>This option disables the manual focusing capability of the electronic ring provided on many USM lenses, eliminating the possibility of accidentally turning the ring and shifting the focus after autofocus is completed.</p> <p>Compatible Lenses</p> <table data-bbox="470 1095 871 1202"> <tr> <td>EF 50/1.0L USM</td> <td>EF 85/1.2L USM</td> </tr> <tr> <td>EF 200/1.8L USM</td> <td>EF 300/2.8L USM</td> </tr> <tr> <td>EF 400/2.8L USM</td> <td>EF 500/4.5L USM</td> </tr> <tr> <td>EF 600/4L USM</td> <td>EF 1200/5.6L USM</td> </tr> <tr> <td>EF 28-80/2.8-4L USM</td> <td></td> </tr> </table>	EF 50/1.0L USM	EF 85/1.2L USM	EF 200/1.8L USM	EF 300/2.8L USM	EF 400/2.8L USM	EF 500/4.5L USM	EF 600/4L USM	EF 1200/5.6L USM	EF 28-80/2.8-4L USM		36
EF 50/1.0L USM	EF 85/1.2L USM											
EF 200/1.8L USM	EF 300/2.8L USM											
EF 400/2.8L USM	EF 500/4.5L USM											
EF 600/4L USM	EF 1200/5.6L USM											
EF 28-80/2.8-4L USM												

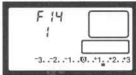
Type	Custom Function No.	Affected Function	LCD Panel Display	Setting No.	Sticker Symbol	
Exposure	F-8	Center-weighted average metering		0		
				1		
	F-9	AEB exposure sequence		0		
				1		
				2		
				3		
	Focus	F-10	Elimination of AF frame display		0	
					1	

Operation	Useful Situations	Reference Page No.
<p>Evaluative metering.</p> <p>Center-weighted average metering.</p> <ul style="list-style-type: none"> The LCD panel still shows the evaluative metering indication. 	<p>Setting this function to center-weighted average metering provides the photographer with a predictable metering pattern for determining exposure. This is useful for experienced photographers who have over many years developed an ability to accurately determine exposure combining average metering and exposure compensation.</p>	<p>38</p>
<p>Under → Correct → Over</p> <p>Under → Correct → Over</p> <p>Correct → Under → Over</p> <p>Correct → Under → Over</p> <ul style="list-style-type: none"> 0 & 2: AEB operation is canceled when main switch is set to "M", lens is exchanged, film is loaded or rewound, bulb exposure mode is set, flash charge completion is detected, or the clear button is pressed. 1 & 3: AEB operation is not canceled when main switch is set to "M", lens is exchanged or film is loaded or rewound. <p>AEB mode can be selected by simultaneous pressing AF mode and shooting mode selectors + main dial operation.</p>	<p>2, 3: These settings change the bracketing sequence to "0 → - → +", which is useful when shooting live subjects or changing scenes where the first shot will most likely capture the best expression or composition.</p> <p>1, 3: These settings are useful for photographers who frequently use AEB, as it prevents AEB mode from being canceled every time the lens is exchanged, the main switch is set to "M", or the film is rewound or exchanged, and allows the user to activate AEB mode using an external setting operation, eliminating the need to open the camera's palm door.</p>	<p>45 47</p>
<p>Focusing point superimposed (red).</p> <p>Superimpose is prohibited.</p>	<p>This option is for users who are annoyed by the AF frame illumination in the viewfinder, as well as for those who frequently use manual focusing to adjust the final focus.</p>	<p>30</p>

Type	Custom Function No.	Affected Function	LCD Panel Display	Setting No.	Sticker Symbol
Focus	F-11	Focusing point selection		0	
				1	
				2	
Mirror operation	F-12	Mirror up operation		0	
Beeping on/off	F-12 (RS)	Beeping when in focus		0	
				1	
Exposure	F-13	Spot metering at the AF frame		0	
				1	
Flash operation	F-14	Fill-in flash control		0	
				1	

Operation	Useful Situations	Reference Page No.
<p>Focusing point selector () + main dial</p> <p>Exposure compensation button () + main dial</p> <p>Independent operation of quick control dial, or exposure compensation button () + main dial.</p> <ul style="list-style-type: none"> Focusing point selection using the quick control dial is possible during metering operation, when the 6-second metering timer is activated, or during continuous shooting in AI Servo AF mode. <p>After the far left or far right focusing point is selected, selection cannot proceed in the same direction.</p>	<p>0, 1: This option makes it possible to match the EOS-1 N's button operations to the photographer's existing camera (EOS-1 or EOS 5•A2/A2E).</p> <p>2: This option lets the user track the subject with the focusing point in real-time by operating the quick control dial, which is useful when tracking a moving subject using the focus prediction control in AI Servo AF mode.</p> <p>To set the aperture during exposure compensation or manual exposure, press the focusing point selection button and turn the main dial.</p>	<p>30 33 60</p>
<p>Normal operation.</p> <p>Mirror up operation.</p>	<p>This is effective for preventing camera shake caused by mirror operation shock when making long exposures. Use of a tripod is recommended.</p>	<p>72</p>
<p>No beeping when the subject is in focus.</p> <p>Beeps when the subject is in focus.</p>	<p>Set to suit your shooting style and the environment.</p> <ul style="list-style-type: none"> In the RS mode, there is no beeping. 	<p>102</p>
<p>Fine spot metering in center of image area.</p> <p>Spot metering linked to the manually selected focusing point.</p> <ul style="list-style-type: none"> In automatic focusing point selection mode, spot metering is carried out for the center focusing point only. 	<p>This function links spot metering to the focusing point, allowing the user to spot meter the subject without changing the framing of the scene.</p>	<p>39</p>
<p>Automatic flash output reduction control active.</p> <p>Automatic flash output reduction control prohibited.</p>	<p>This function prevents underexposure of strongly backlit subjects, such as when shooting portraits backed by light from the late afternoon sun.</p>	<p>77</p>

Custom Function Chart

● Combined Use of Custom Functions F-5 and F-11

When custom functions F-5 and F-11 are combined, shutter speed and aperture value settings are carried out as shown in the following table.

Custom function number		F-5	
	Selection No.	0	1
F-11	0	Shutter speed: Set by main dial Aperture value: 1) Set by quick control dial or 2) Set by exposure compensation button (\pm) and main dial	Aperture value: Set by main dial Shutter speed: 1) Set by quick control dial or 2) Set by exposure compensation button (\pm) and main dial
	1	Shutter speed: Set by main dial Aperture value: 1) Set by quick control dial or 2) Set by focusing point selector (\square) and main dial	Aperture value: Set by main dial Shutter speed: 1) Set by quick control dial or 2) Set by focusing point selector (\square) and main dial
	2	Shutter speed: Set by main dial Aperture value: Set by focusing point selector (\square) and main dial	Aperture value: Set by main dial Shutter speed: Set by focusing point selector (\square) and main dial

Additional Information for the EOS-1 N DP Model

A combination of the EOS-1 N with the compact Battery Pack BP-E1 provides a switch that lets you power the camera either from the standard 2CR5 lithium battery stored in the grip or from four AA-size (LR6) alkaline-manganese or Ni-Cd batteries housed in the battery pack. This dual pack (DP) system lets you use AA-size batteries during normal temperature shooting and switch to the 2CR5 lithium battery when shooting in cold conditions. Moreover, the camera will operate even when only one of the two battery types is installed. Also, the Handstrap E1 (optional) can be attached to improve holding stability.

- Battery Pack BP-E1 is compatible with both the EOS-1 N and the EOS-1.

● Nomenclature

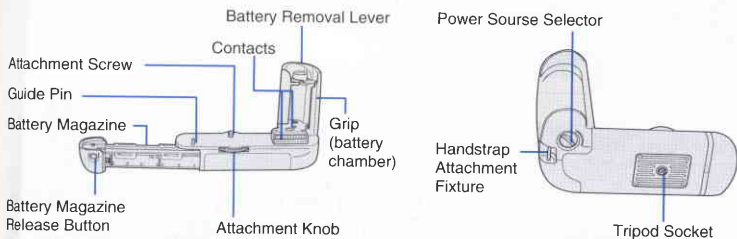

● Loading Batteries

- 1 Turn the Battery pack BP-E1's attachment knob in the direction of the arrow and remove the BP-E1 from the camera.
- 2 Load the lithium 2CR5 battery so that battery contacts contact the Battery pack BP-E1's contacts in the grip.

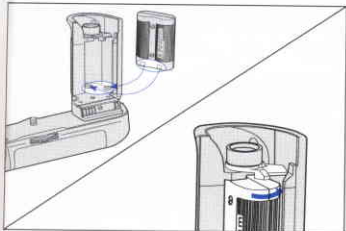
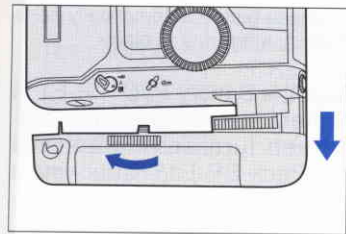

Additional Information for the EOS-1 N DP Model

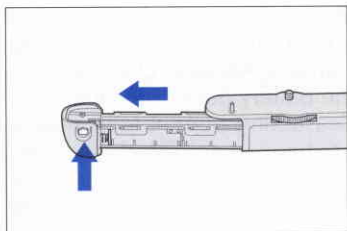

- 3 Press the Battery Pack BP-E1's battery magazine release button and remove the battery magazine.

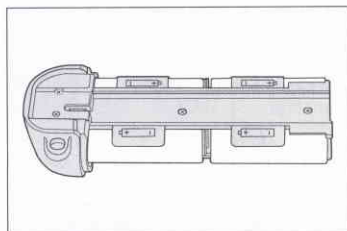

- 4 Insert four AA-size batteries into the battery magazine as shown in the diagram.

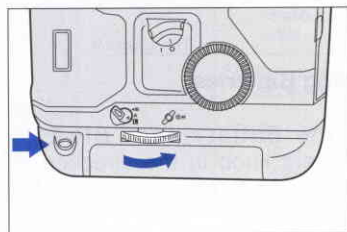

- 5 Insert the battery magazine into the Battery Pack BP-E1.
 - The release button automatically holds the battery magazine in place.
- 6 Reattach the Battery Pack BP-E1 to the camera as shown in the diagram, then turn and tighten the Battery Pack BP-E1's attachment knob.

Additional Information for the EOS-1 N DP Model

1. Power Source Selector

Use the power source selector to select the desired power source. The relationship between the selector and power source is as follows:

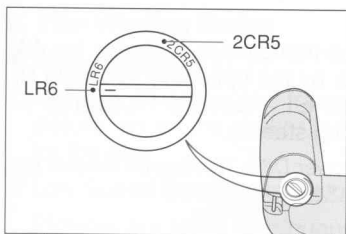

- 1) 2CR5: Camera is powered from the 2CR5 lithium battery stored in the grip.
 - 2) LR6: Camera is powered from the AA-size alkaline-manganese or Ni-Cd batteries housed in the battery magazine.
- Do not change the power source during camera operation (such as during film rewinding or long exposures), since it may cause misoperation.



- Canon recommends that AA-size lithium batteries not be used in this product since its initial high voltage may cause damage to the product.

2. Shooting Capacity

Temperature	Shooting capacity by battery type (rolls)		
	2CR5 lithium	AA-size alkaline	AA-size Ni-Cd
Normal (+20°C)	75 (50)	45 (30)	18 (12)
Low (-20°C)	12 (8)	0 (0)	12 (8)

- Data based on Canon's Standard Test Method using new batteries, EF50mm f/1.4 USM lens and 24-exposure film. Values in parentheses are for 36-exposure film.
- Repeated autofocus operation without taking any pictures will reduce the overall shooting capacity.

Additional Information for the EOS-1 N HS Model

A combination of the EOS-1 N with the Power Drive Booster E1 expands the choice of film winding modes to three and benefits from higher shooting capacity (refer to page 98). Moreover, the EOS-1 N HS is designed for improved operability with features such as a separate shutter button and AE lock button (✱) for vertical shooting.

Power is supplied by eight AA-size alkaline-manganese batteries (or AA-size Ni-Cd or AA-size lithium batteries*), or by the optionally available Ni-Cd Pack E1 and dedicated Ni-Cd Charger E1. Also, the Handstrap E1 (optional) can be attached to improve holding stability.

* AA-size lithium batteries can be used with Power Drive Booster E1 models that are marked with the AE lock button indication "✱".

● Nomenclature

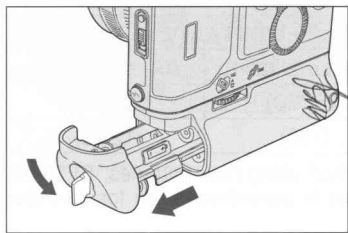
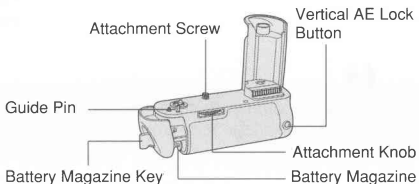
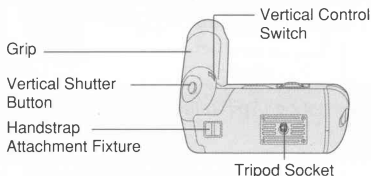

● Loading Batteries

1 Turn the Power Drive Booster E1's battery magazine key 90° (quarter turn only) and remove the battery magazine.

- To re-install the battery magazine, perform the reverse procedure.

2 Insert eight AA-size batteries into the battery magazine as shown in the diagram.



The above procedure is also used when loading batteries into the EOS-1 N RS.

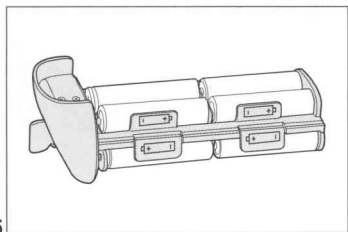

Additional Information for the EOS-1 N HS Model

1. Vertical Position Shooting

To use the vertical shutter button and AE lock button set the vertical control switch to the ON position (red dot showing).

2. Film Winding Modes

● Single Exposure (□)

The film advances one frame after each picture is taken. After taking a picture, return the shutter button to the half-pressed position to prepare for the next exposure.

● Low-Speed Continuous Exposure (□_L)

Pictures are taken continuously at a rate of up to approx. 3 frames per second as long as the shutter button is held pressed.

● High-Speed Continuous Exposure (□_H)

Pictures are taken continuously at a rate of up to approx. 6 frames per second as long as the shutter button is held pressed.

3. Maximum Continuous Shooting Speed in Different AF Modes

	One-shot AF/Manual	AI Servo AF
Low-speed continuous (□ _L)	Approx. 3 fps	Approx. 2.5 fps
High-speed continuous (□ _H)	Approx. 6 fps	Approx. 5 fps



- AA-size lithium batteries can only be used with the EOS-1 N combined with a power Drive Booster E1 that has a " * " symbol printed on the AE lock button. Canon recommends that AA-size lithium batteries not be used in this product since its initial high voltage may cause damage to the product.

Additional Information for the EOS-1 N HS Model

4. Shooting Capacity

		Shooting capacity by battery type (rolls)		
Temperature	Power source	AA-size alkaline	Ni-Cd Pack E1	Size AA lithium batteries (FR6x8)
	Normal (+20°C / 68°F)		100 (65)	65 (45)
Low (-20°C / -4°F)		6 (4)	45 (30)	90 (60)

- Data based on Canon's Standard Test Method using new batteries, EF50mm f/1.4 USM lens and 24-exposure film. Values in parentheses are for 36-exposure film.
- Repeated autofocus operation without taking any pictures will reduce the overall shooting capacity.

Attaching the Standard Grip

The Battery Pack BP-E1 or Power Drive Booster E1 can be removed and replaced with the EOS-1 N's standard grip GR-E1 (optional) using the procedure below.

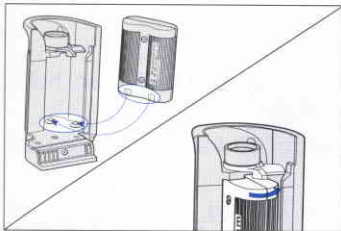

- 1 Load a battery into the standard grip GR-E1 (see page 14).

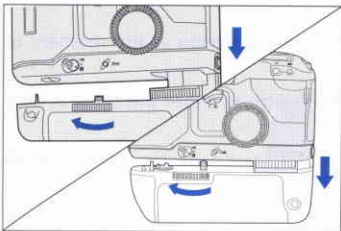

- 2 Turn the Battery Pack BP-E1/Power Drive Booster E1's attachment knob to loosen, then pull the assembly downward to remove from the camera.

For EOS-1 N HS users, attach the booster coupler cover (supplied with the GR-E1) to the camera's booster coupler.

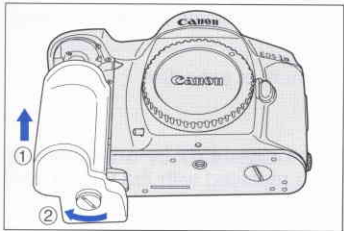

- 3 Attach the standard grip to the camera, and tighten the attachment screw so that the grip is firmly attached.

- 4 Attach the contact protector cover (supplied with the GR-E1) to the Battery Pack BP-E1/Power Drive Booster E1 to protect the electronic contacts.

Additional Information for the EOS-1 N RS Model

In addition to all the features of the EOS-1 N, the EOS-1 N RS also has a fixed, hard-coat, new pellicle mirror, a high-speed motor drive, and the RS mode. The EOS-1 N RS is a single-lens reflex camera having the fastest AF (autofocus) operation.

Major Features of the EOS-1 N RS

- In the RS mode, the short shutter release time lag of 0.006 sec. helps you capture the decisive moment more easily.
- A high-speed continuous shooting speed of 10 frames per sec. can be attained.
- Since the hard-coat, new pellicle mirror is fixed, the image in the viewfinder is not blocked out during the exposure. This brings the following advantages:
 - While looking through the viewfinder, you can see the image at the moment of exposure.
 - While looking through the viewfinder, you can confirm whether the flash is synchronized.
 - Even during continuous shooting, the subject's image in the viewfinder is steady.
 - For flash photography at slow shutter speeds, it is easier to decide the timing of the flash.
 - For multiple flash exposures or multiple exposures on a single frame, it is easier to set the composition.
 - You can notice any camera shake during the moment of exposure.

Note:

- The EOS-1 N RS's battery magazine cannot be separated from the camera body. Therefore, the battery magazine cannot be replaced with the GR-E1 normal grip or the BP-E1 size AA battery pack.

Additional Information for the EOS-1 N RS Model

● Nomenclature

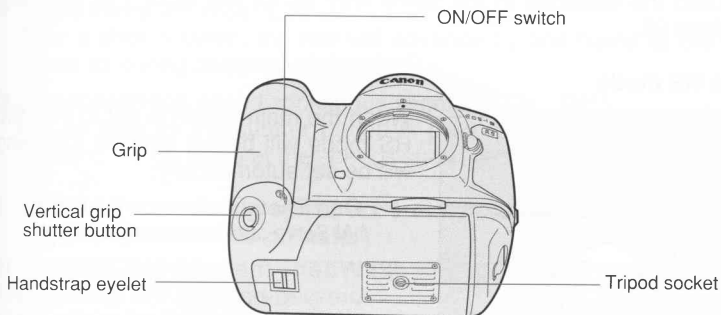

● Using the vertical grip

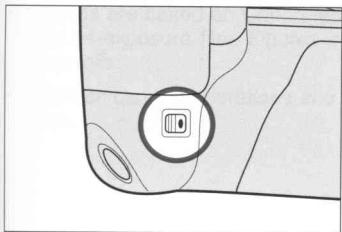

To use the vertical grip and the corresponding shutter button and AE lock button, turn on the ON/OFF switch.

Additional Information for the EOS-1 N RS Model

1. Batteries for the EOS-1 N RS

- Load the batteries in the same way as for the EOS-1 N HS. See page 98.

2. The RS mode

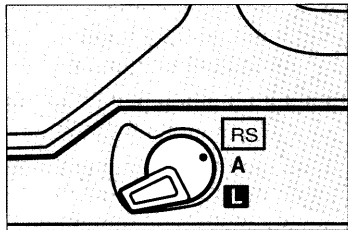

When the main switch is set to RS, the RS mode will be set and the following will be set automatically:

- (1) One Shot autofocus will be set.
* AI Servo autofocus cannot be set.
- (2) When the shutter button is pressed halfway, the aperture will stop down immediately after focusing is achieved.
- (3) The shutter release time lag will be 0.006 sec.

3. Custom functions

Other than custom function No. F-12, the custom functions are the same as for the EOS-1 N. Custom function No. F-12 is described below.

Custom Function F 12

(Refer to pages 92)

Beeping when the subject is in focus during One Shot autofocus or manual focus can be turned on or off.

Additional Information for the EOS-1 N RS Model

4. Film advance mode

- Single frame advance ()

After a shot is taken, the film will advance by one frame at the same speed as during continuous shooting.

- Low-speed/High-speed continuous shooting (_L / _H)

For as long as the shutter button is pressed completely, continuous shooting will continue at the speeds shown in the table below.

5. Continuous shooting speed according to AF mode (frames/sec. at shutter speeds 1/250 or faster)

	RS Mode	Normal Modes	
		One-shot AF/Manual	AI Servo AF
Low-speed continuous (<input type="checkbox"/> _L)	Approx. 3 fps	Approx. 3 fps	Approx. 2.5 fps
High-speed continuous (<input type="checkbox"/> _H)	Approx. 10 fps	Approx. 6 fps	Approx. 5 fps

* At shutter speeds 1/1000 sec. or faster.

6. Battery service life in terms of film rolls

Power source Temperature	Shooting capacity by battery type (rolls)		
	AA-size alkaline	Ni-Cd Pack E1	Size AA lithium batteries (FR6x8)
Normal (+20°C / 68°F)	100 (65)	65 (45)	250 (165)
Low (-20°C / -4°F)	6 (4)	45 (30)	90 (60)

- Figures are based on Canon tests using new batteries, an EF 50mm f/1.4 lens, and 24-exposure film. Figures in parentheses indicate the number of 36-exposure rolls.
- Filmless camera operations and autofocus operations will reduce the above figures.

8. EOS-1 N RS Operation Notes



- When the shutter button is pressed lightly, there will be a sound as if the shutter was released. This is only the shutter's rear curtain positioning itself.
- Use a blower brush to lightly blow off any dust from the pellicle mirror. If the mirror is really dirty, consult your nearest Canon Service Center.
- During self-timer operation, etc., when the eyepiece is left uncovered, light entering through the eyepiece may affect the proper exposure setting. It may even strike the film. Be sure to cover the eyepiece with the eyepiece shutter.



- During manual flash photography, use the following formula to compensate for the reduced amount of light reaching the film due to the pellicle mirror.
Guide No. $\times 0.8$ / Subject distance = Aperture setting
- When the Canon Speedlite 480EG is used for automatic flash photography, increase the normal aperture setting by 2/3 stop or decrease the 480EG's ISO setting by 2/3 EV (open up) to compensate for the reduced amount of light reaching the film due to the pellicle mirror.
- The flash distance range for automatic flash exposures will be 20 percent shorter than the flash unit's specified distance range. (The 420EZ, 430EZ, and 540EZ flash unit's will display the flash distance range after the compensation is set.)
- When using a handheld exposure meter to set the exposure manually, set an exposure compensation of +2/3 EV or set the handheld meter's ISO setting to 2/3 EV less than the normal ISO. This is to compensate for the reduced amount of light reaching the film due to the pellicle mirror.
- When the EF 50mm f/1.0L USM lens is used, vignetting will occur due to the frame holding the fixed pellicle mirror in place.

Additional Information for the EOS-1 N RS Model



- When custom function CF-4 is set to "1" (AF operation with the AE lock button and AE lock with the shutter button pressed halfway) and the RS mode is used, allow the autofocus operation to be completed before pressing the shutter button halfway.
 - * If the shutter button is pressed halfway, the autofocus will not operate even when the AE lock button is pressed.
 - * If the AE lock button is pressed and the shutter button is pressed halfway during the autofocus operation, the aperture will stop down after focusing is achieved.
- Do not use Command Back E1 if you want a high continuous shooting speed. Using Command Back E1 while in the RS mode will give a maximum continuous shooting speed of only 1 frame/sec. even without any data being imprinted. Also, if data is imprinted, the maximum continuous shooting speed will vary depending on the film's ISO rating. For ISO 64 film, it will be 4 frames/sec.
- In the RS mode, AEB cannot be used.

Troubleshooting

If you run into a problem operating your camera, check the following table to see if you can find the cause of the problem. If the trouble persists, take the camera to your nearest Canon service center. (A list of service centers is provided at the back of this instruction book.)

Symptom	Cause	Remedy	Referral page
Nothing appears in the LCD panel.	The main switch is set to L .	Set the main switch to A or ■ .	16
	The battery is exhausted.	Replace the battery with a new one.	14
	The battery is inserted upside down.	Reload the battery correctly.	14
The automatic film loading function does not operate.	The main switch is set to L .	Set the main switch to A or ■ .	16
	The film is not loaded correctly. (The film transport (wind/rewind) (----) is blinking in the LCD panel.)	Remove the film and reload it correctly.	23
The camera settings cannot be changed.	The main switch is set to L .	Set the main switch to A or ■ .	16
	The quick control dial switch is not set to I .	Set the quick control dial switch to I .	10
Autofocusing does not operate.	The lens' focus mode switch is set to M .	Set the lens' focus mode switch to AF .	18
	Custom function F-4 is set to 1.	Press AE lock button to autofocus, or set custom function F-4 to 0 and press shutter button halfway.	82 84
The shutter does not release.	The main switch is set to L .	Set the main switch to A or ■ .	16
	The film is not loaded correctly. (The film transport (wind/rewind) (----) is blinking in the LCD panel.)	Remove the film and reload it correctly.	23
	A roll of rewind film is still in the camera. (The film rewind completion (Ⓢ) is blinking in the LCD panel.)	Remove the exposed film and load a new roll.	25

Symptom	Cause	Remedy	Referral page
The shutter does not release.	The subject is not focused. (The in-focus indicator is blinking in the viewfinder.)	Press the shutter button again halfway to refocus the subject. If the subject still cannot be focused, refer to "3. Difficult Subjects for Autofocus" on page 34.	20
The film does not rewind.	The camera is being used in a cold environment.	The battery capacity quickly depleted due to the cold. Replace it with a new battery.	14
	Custom function F-1 is set to 1 or 3.	Set custom function F-1 to 0 or 2.	82 84
"bc" blinks in the LCD panel.	The battery is extremely depleted.	Replace the battery with a new one. If the "bc" indicator goes out, the camera will operate normally.	7
	The camera has undergone some type of malfunction.	Remove the battery from the camera and reload it. If the blinking "bc" indicator disappears, the camera will operate normally. <ul style="list-style-type: none"> If the "bc" indicator does not stop blinking after repeating the above operations several times, there is a malfunction in the camera. Take the camera to your nearest Canon service center for diagnosis and repair. 	7 14 Back cover

Program Line Characteristics

Program characteristics for Program AE [P] mode using an EF50mm f/1.4 USM lens.

For EOS-1 N mounted with an EF 50mm f/1.4 USM lens

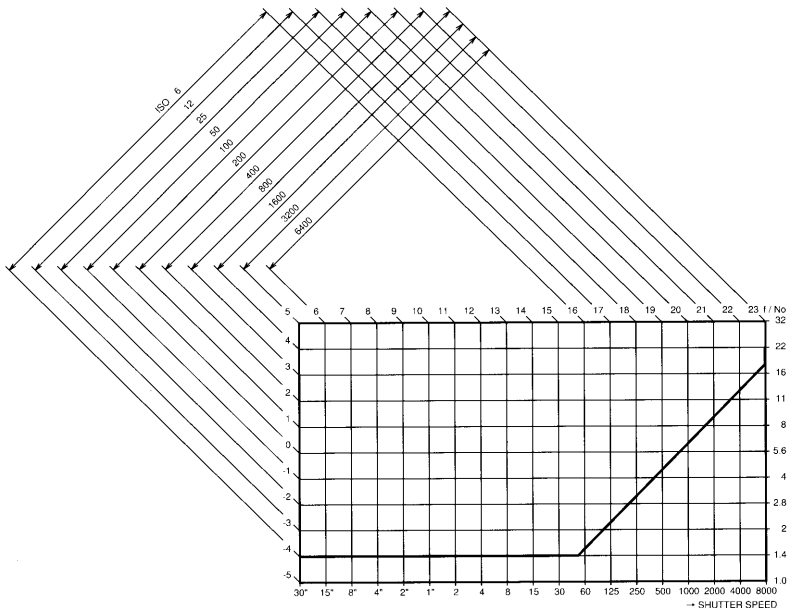

Specifications

RS indicates the specification for the EOS-1 N RS

■ TYPE AND MAJOR COMPONENTS

Type:	35mm focal plane shutter SLR (single-lens reflex) camera with autofocus, auto exposure and built-in motor drive.
Format:	24 mm × 36 mm
Usable Lenses:	Canon EF lenses
Lens Mount:	Canon EF mount (fully electronic signal transfer system)

■ VIEWFINDER

Type:	Fixed eye-level pentaprism.
Coverage:	Gives 100% vertical and horizontal coverage of actual picture area.
Magnification:	0.72 × (−1 dpt, with 50mm lens at infinity).
Standard diopter:	−1 dpt, built-in dioptic adjustment mechanism provided with adjustment range of −3 ~ +1 dpt (eyepoint: 20 mm).
Focusing Screen:	Interchangeable (8 types available); standard screen: Ec-CII. RS Interchangeable (8 screens) by a Canon Service Center. Type Ec-R installed as standard equipment.
Mirror:	Quick return half-mirror (Mirror blockage: None to 1200mm f/5.6) RS Fixed pellicle mirror (transmission:reflection = 65:35)
Viewfinder Information:	(1) Within viewing area: Five focusing points, fine spot metering area mark (with Ec-CII) (2) Below viewing area: Shutter speed, aperture value, * (AE lock, blinks at 2 Hz during AEB operation), M (manual), † (flash charge completion indicator), ‡ (lights when exposure compensation or flash exposure compensation is set), ● (in-focus indicator, blinks at 8 Hz when AF is impossible)

Specifications

Depth-of-Field Preview:	<p>(3) To the right of viewing area: Exposure level scale (± 3 stops in 1/3-stop increments), exposure level indicator (① AE mode, exposure compensation amount, ② AE lock, real-time meter deviation value, ③ manual exposure level, ④ AEB step amount, ⑤ background exposure when using flash), remaining frame number display</p> <p>Possible, by operation of depth-of-field preview button.</p>
■ EXPOSURE CONTROL	
Light Metering:	TTL full-aperture metering using a 16-zone SPC (silicon photocell). Five metering modes available: evaluative metering, partial metering (covers approx. 9% of the central picture area), fine spot metering (covers approx. 2.3% of the central picture area: In continuous exposure mode, first frame metered in real time, second and successive frames shot at same settings (AE lock)), spot metering (covers approx. 3.5% of the picture area at each AF frame position) and center-weighted average metering.
Shooting Modes:	① Shutter-priority AE (1/3-stop increments) ② Aperture-priority AE (1/3-stop increments) ③ Depth-of-Field AE ④ Intelligent Program AE ⑤ A-TTL program flash AE ⑥ TTL program flash AE ⑦ Manual exposure ⑧ Bulb
Metering Range:	<p>[RS] No depth-of-field-priority AE.</p> <p>At normal temperature with 50mm f/1.4 lens at ISO 100: ① Evaluative metering, partial metering: EV 0 ~ 20 ② Fine spot metering: EV 3 ~ 20</p> <p>[RS] ① EV 1-20 for evaluative and partial metering*, ② EV 1-20 for fine spot metering* (*At room temperature with a 50mm f/1.4 lens and ISO 100 film.)</p>
Usable film speeds:	ISO 6~6400 (ISO 25~5000 when automatically set by DX code)
Exposure Compensation:	<p>(1) AEB: ± 3 stops in 1/3-stop increments, shot according to film winding mode in sequence of underexposure \rightarrow correct exposure \rightarrow overexposure; repeatable, can be used with self-timer for delayed 3-sequence exposure.</p> <p>[RS] In the RS mode, AEB cannot be set.</p>

Specifications

AF Working Range:	(3) Manual focusing: Possible by setting the lens' focus mode switch to "M" and operating the lens' manual focusing ring. In-focus indicator lights up when focus is achieved (with EF lenses having maximum aperture of f/5.6 or larger). [RS] Manual focusing with the electronic ring is enabled during exposure and continuous shooting. EV 0 ~ 18 (ISO 100).
■ SHUTTER	
Type:	Vertical-travel, focal plane shutter with all speeds electronically controlled.
Shutter Speed:	[RS] Electronically-controlled (at all speeds), vertical-travel, double curtain focal-plane shutter 1/8000 ~ 30 sec. (in 1/3-stop increments) and bulb. Maximum X-sync speed: 1/250 sec.
Shutter Release:	Soft-touch electromagnetic release. [RS] Shutter release time lag In the RS mode, the exposure starts 0.006 sec. after the shutter button is pressed down fully.
Self-timer:	Electronically controlled with 2- or 10-second delay, selectable; operation indicated by blinking lamp (blinking speed: 2 Hz when first activated, increasing to 8 Hz for final two seconds); self-timer counted down in camera's LCD panel; can be automatically canceled by setting the main switch to "L".
■ FILM TRANSPORT	
Film Loading:	Automatic. Film automatically advances to first frame when back cover is closed.
Film Wind:	Automatic using built-in motor. (1) EOS-1 N alone: Two modes available: <input type="checkbox"/> (single exposure) and <input type="checkbox"/> (continuous exposure). (2) With Power Drive Booster E1 attached: Three modes available: <input type="checkbox"/> (single exposure), <input type="checkbox"/> L (low-speed continuous exposure) and <input type="checkbox"/> H (high-speed continuous exposure). [RS] Three modes: (single frame), (low-speed continuous shooting), (high-speed continuous shooting)

Film Rewind:

Automatic rewind at end of roll using built-in motor. (Rewind speed with 24-exp. film: approx. 5 sec; with 36-exp. film: approx. 8 sec.); mid-roll rewind possible. Rewind noise: Normal mode: 59 dB; Silent mode: 48 dB.

[RS] High-speed film rewind: Approx. 5 sec. for 24-exposure film and 8 sec. for 36-exposure film Silent film rewind for 24-ex. and 36-ex. films: Approx. 13 sec. and 20 sec. respectively

■ CAMERA BODY

Flash Contacts:

- (1) Accessory shoe:
X contact, directly-coupled contacts
- (2) PC terminal:
JIS B socket (with lock screw)
* (1) and (2) can be used at the same time.

Automatic Flash Exposure:

- **X-sync Shutter Speed and Aperture Settings**
(with EOS dedicated speedlites)

Shooting mode	X-sync shutter speed	Aperture value
P (program AE)	Automatically set to 1/60 ~ 1/250 sec. based on A-TTL or TTL program	Automatically set according to A-TTL or TTL program
Tv (Shutter-priority AE)	Manually set to any shutter speed of 1/250 or slower.*	Automatically set according to ambient light level and shutter speed.
Av (Aperture-priority AE)	Automatically set between 30 sec. and 1/250 sec. according to ambient light level and set aperture value.	Manually set to desired aperture.
M (Manual exposure)	Manually set to any shutter speed of 1/250 or slower.	Manually set to desired aperture.

* If a shutter speed faster than 1/250 sec is set, the camera automatically sets the shutter speed to 1/250 sec.

Fourteen built-in custom functions selectable by user: (1) Automatic film rewind setting, (2) Film leader status at end of rewind, (3) Film speed setting, (4) AF activation method, (5) Manual shutter speed and aperture value setting method, (6) Shutter speed, aperture value, exposure compensation, flash exposure compensation and AEB setting increments,

Specifications

Custom Function Control:	<p>(7) Manual focusing using the electronic manual focusing ring, (8) Selection of center-weighted average metering, (9) AEB shooting sequence, (10) Cancellation of superimposed focusing points, (11) Focusing point selection method, (12) Mirror up photography, (13) Spot metering linked to focusing points, (14) flash output control.</p> <p>RS Except for custom function No. F-12, same as in the EOS-1 N.</p> <p>F-12 set to "0": No beeping when autofocus is achieved in the A mode.</p> <p>F-12 set to "1": Beeping when autofocus is achieved in the A mode. (No beeping in the RS mode.)</p>
LCD Panel:	<p>Displays necessary information including AF mode, film winding mode, metering mode, shutter speed, aperture value, film speed, battery condition and exposure compensation.</p>
Remote Control:	<p>3-pin remote control socket provided.</p>
Battery:	<p>(1) One six-volt 2CR5 lithium battery, housed in the grip; (2) When the Power Drive Booster E1 is attached, the lithium battery is removed and power is supplied from the booster's power source (eight AA-size alkaline-manganese batteries [or AA-size Ni-Cd batteries or AA-size lithium batteries] or Ni-Cd Pack E1); (3) When the AA-size battery pack BP-E1 is attached, power is supplied either by the camera's lithium battery or by four AA-size alkaline-manganese or Ni-Cd batteries.</p> <p>RS 8 size AA alkaline manganese batteries (Ni-Cd or lithium) or Ni-Cd Battery Pack E1</p>
Battery Check:	<p>By pressing the battery check button; battery level shown in four-step display in the LCD panel</p>
Camera Back:	<p>Interchangeable with the optionally available Command Back E1.</p>
Dimensions:	<p>161 (W) × 112.1 (H) × 71.8 (D) mm 6-5/16" (W) × 4-7/16" (H) × 2-13/16" (D)</p> <p>RS 6-5/16" (W) × 6-1/8" (H) × 3-1/16" (D) mm</p>
Weight:	<p>855 gr / 30 oz without battery (body only, without lithium battery)</p> <p>RS 1,295 gr / 36.7 oz (including battery magazine without batteries)</p>

Quick Guide to EOS-1 N Functions

Make sure the main switch is set to "A" before performing the following operations:

Power source related

Check the battery level
(refer to page 15)

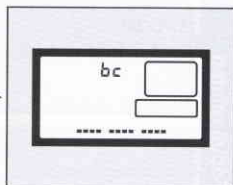
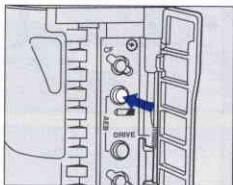

Film related

Check the set film speed
(refer to page 22)

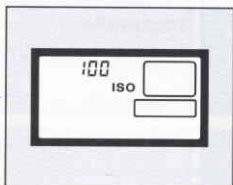
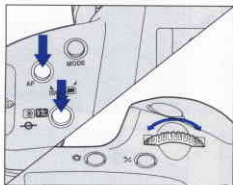

Take pictures in rapid sequence
(refer to page 67)

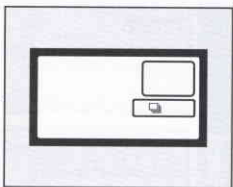
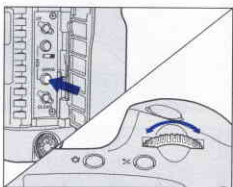

Rewind the film in mid-roll
(refer to page 25)

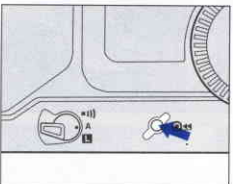

Focus related

Select the focusing point
(refer to page 29)

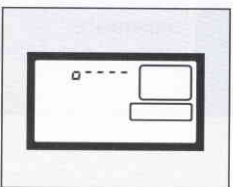
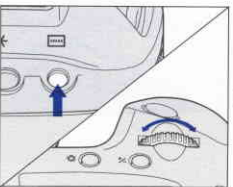

Quick Guide to EOS-1 N Functions

Focus related

Select the AF mode
(refer to page 32)

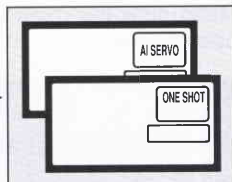
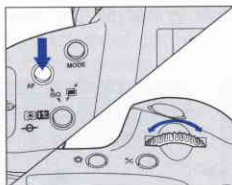

Focus the subject manually
(refer to page 36)

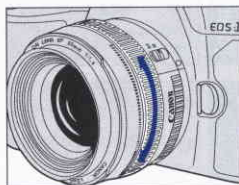
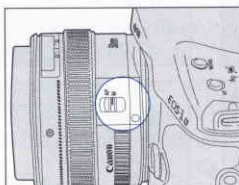

Select the shooting mode
(refer to page 48)

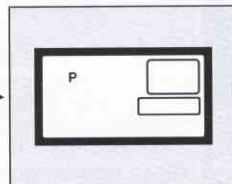
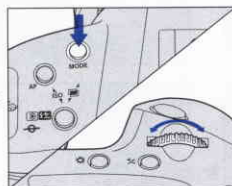

Exposure related

Select the metering mode
(refer to page 37)

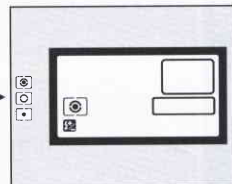
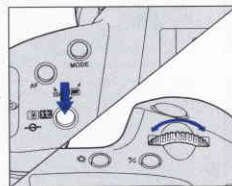

Compensate the exposure
(refer to page 42-44)

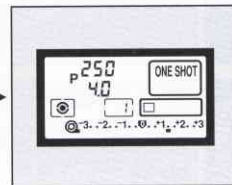
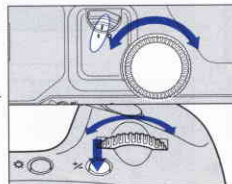

Exposure related

Use AE lock to lock the exposure reading (refer to page 40)

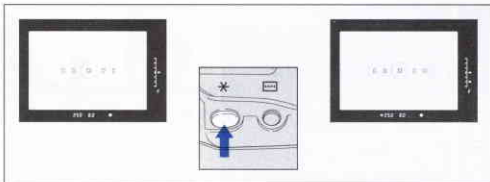

Photographic applications

Take multiple exposures on one frame (refer to page 63)

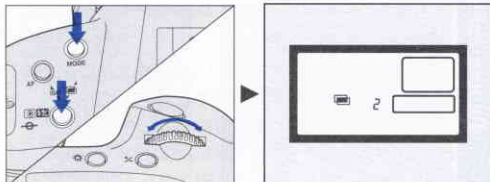

Use automatic exposure bracketing (refer to page 45)

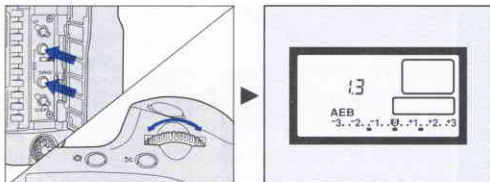

Compensate the flash exposure (refer to page 78)

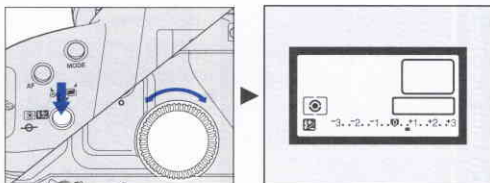

Use the self-timer (refer to page 70)

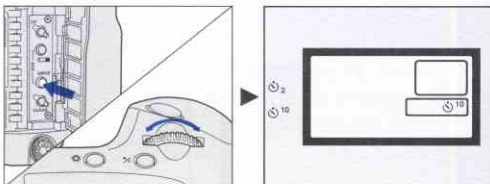

Quick Guide to EOS-1 N Functions

Photographic applications

Illuminating the LCD panel
(refer to page 74)

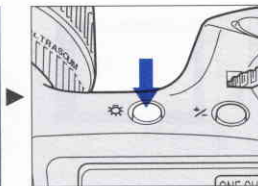

Reset all functions (clear button)
[except for custom functions]
(refer to page 75)

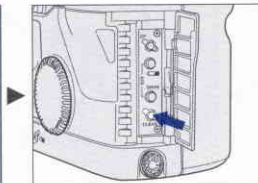

Set a custom function
(refer to page 82)

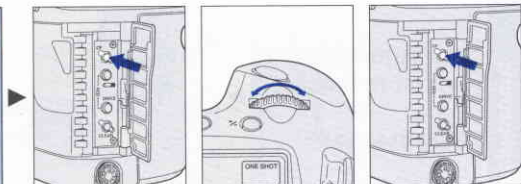

Custom functions

Check the current custom function settings
(refer to page 83)

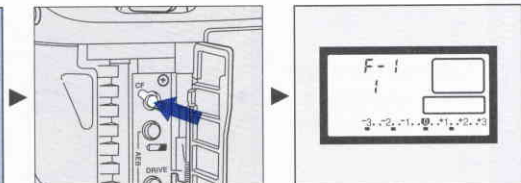

Reset all custom functions at once
(refer to page 75)

